

1996 Ninja® ZX™-9R PARTS DIAGRAM

Engine Cover(s)

E1431

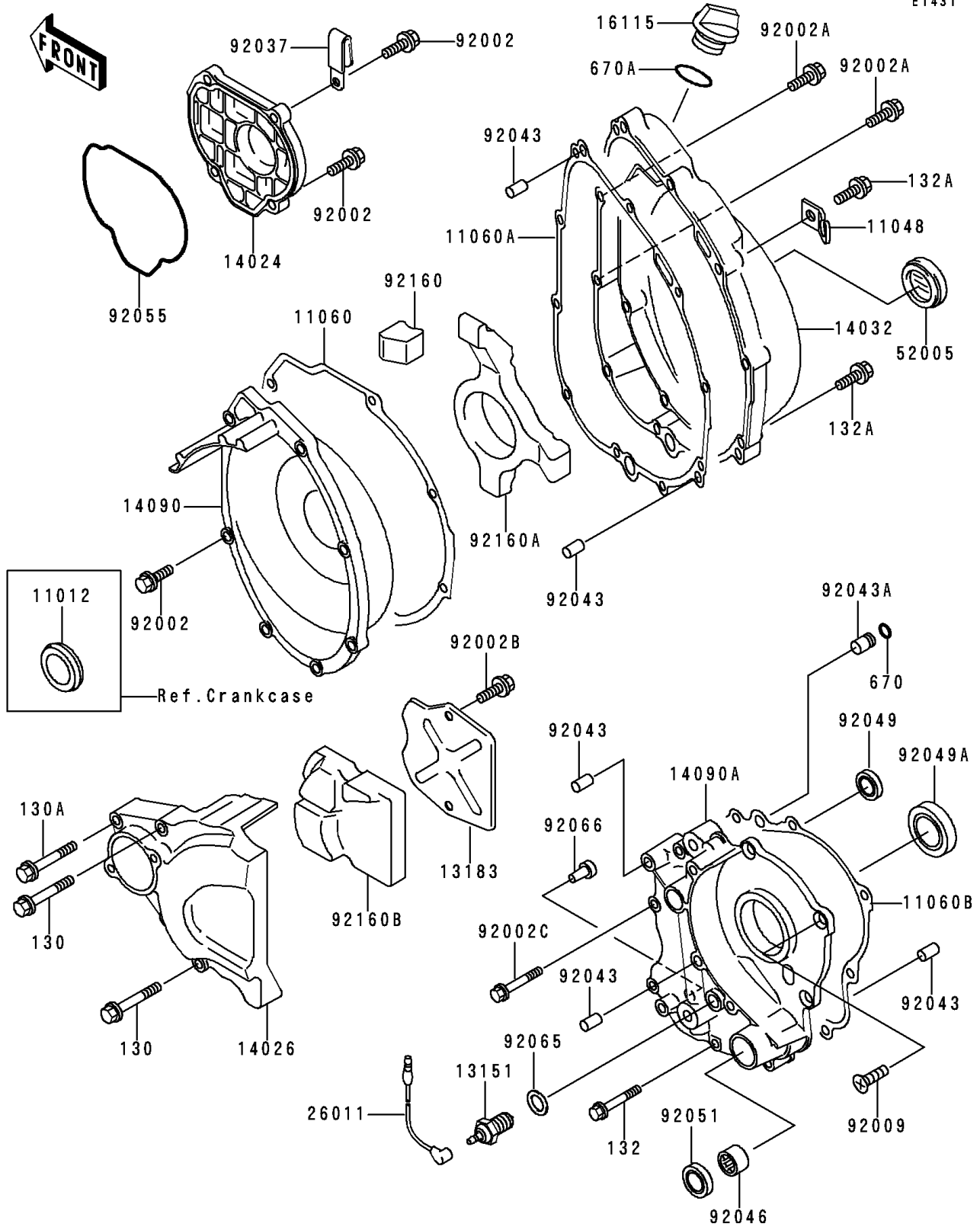

1996 Ninja® ZX™-9R PARTS LIST

Engine Cover(s)

ITEM NAME	PART NUMBER	QUANTITY
BOLT-FLANGED,6X35 (Ref # 130)	130J0635	2
BOLT-FLANGED,6X45,BLACK (Ref # 130A)	130J0645	2
BOLT-FLANGED-SMALL (Ref # 132)	132E0630	2
BOLT-FLANGED-SMALL (Ref # 132A)	132J0630	8
O RING,5MM (Ref # 670)	670B1505	1
O RING,20MM (Ref # 670A)	670B2020	1
CAP,LH,RCA378 (Ref # 11012)	11012-1540	1
BRACKET,THROTTLE ADJUST SCREW (Ref # 11048)	11048-1798	1
GASKET,BREATHER COVER (Ref # 11060)	11060-1356	1
GASKET,CLUTCH COVER (Ref # 11060A)	11060-1623	1
GASKET,TRANSMISSION COVER (Ref # 11060B)	11060-1660	1
SWITCH-COMP,NEUTRAL (Ref # 13151)	13151-1080	1
PLATE,CHAIN COVER (Ref # 13183)	13183-1717	1
COVER,PULSING (Ref # 14024)	14024-1998	1
COVER-CHAIN (Ref # 14026)	14026-1207	1
COVER-CLUTCH (Ref # 14032)	14032-1367	1
COVER,BREATHER (Ref # 14090)	14090-1052	1
COVER,TRANSMISSION (Ref # 14090A)	14090-1673	1
CAP-OIL FILLER (Ref # 16115)	16115-1053	1
WIRE-LEAD (Ref # 26011)	26011-1510	1
GAUGE,OIL LEVEL (Ref # 52005)	52005-1057	1
BOLT,6X20 (Ref # 92002)	92002-1343	11
BOLT,6X25 (Ref # 92002A)	92002-1344	2
BOLT,6X10 (Ref # 92002B)	92002-1449	2
BOLT,6X30 (Ref # 92002C)	92002-1622	3
SCREW,6X16 (Ref # 92009)	92009-1360	3
CLAMP,WIRING HARNESS (Ref # 92037)	92037-1877	1
PIN,6.2X8X14 (Ref # 92043)	92043-1263	5
PIN (Ref # 92043A)	92043-1456	1

1996 Ninja® ZX™-9R PARTS LIST

Engine Cover(s)

ITEM NAME	PART NUMBER	QUANTITY
BEARING-NEEDLE, HK1312 (Ref # 92046)	92046-1148	1
SEAL-OIL, SD-8187 (Ref # 92049)	92049-1017	1
SEAL-OIL, TC32488 (Ref # 92049A)	92049-1361	1
SEAL-OIL, TB13225.5 (Ref # 92051)	92051-005	1
RING-O, PULSING COVER (Ref # 92055)	92055-1494	1
GASKET, 10.5X16X1, DRAIN PLUG (Ref # 92065)	92065-058	1
PLUG (Ref # 92066)	92066-1412	1
DAMPER, SOUND ARRESTER (Ref # 92160)	92160-1282	1
DAMPER, SOUND ARRESTER (Ref # 92160A)	92160-1465	1
DAMPER, CHAIN COVER (Ref # 92160B)	92160-1484	1