

# 1996 Ninja® ZX™-9R PARTS DIAGRAM

Oil Pump/Oil Filter

E1710

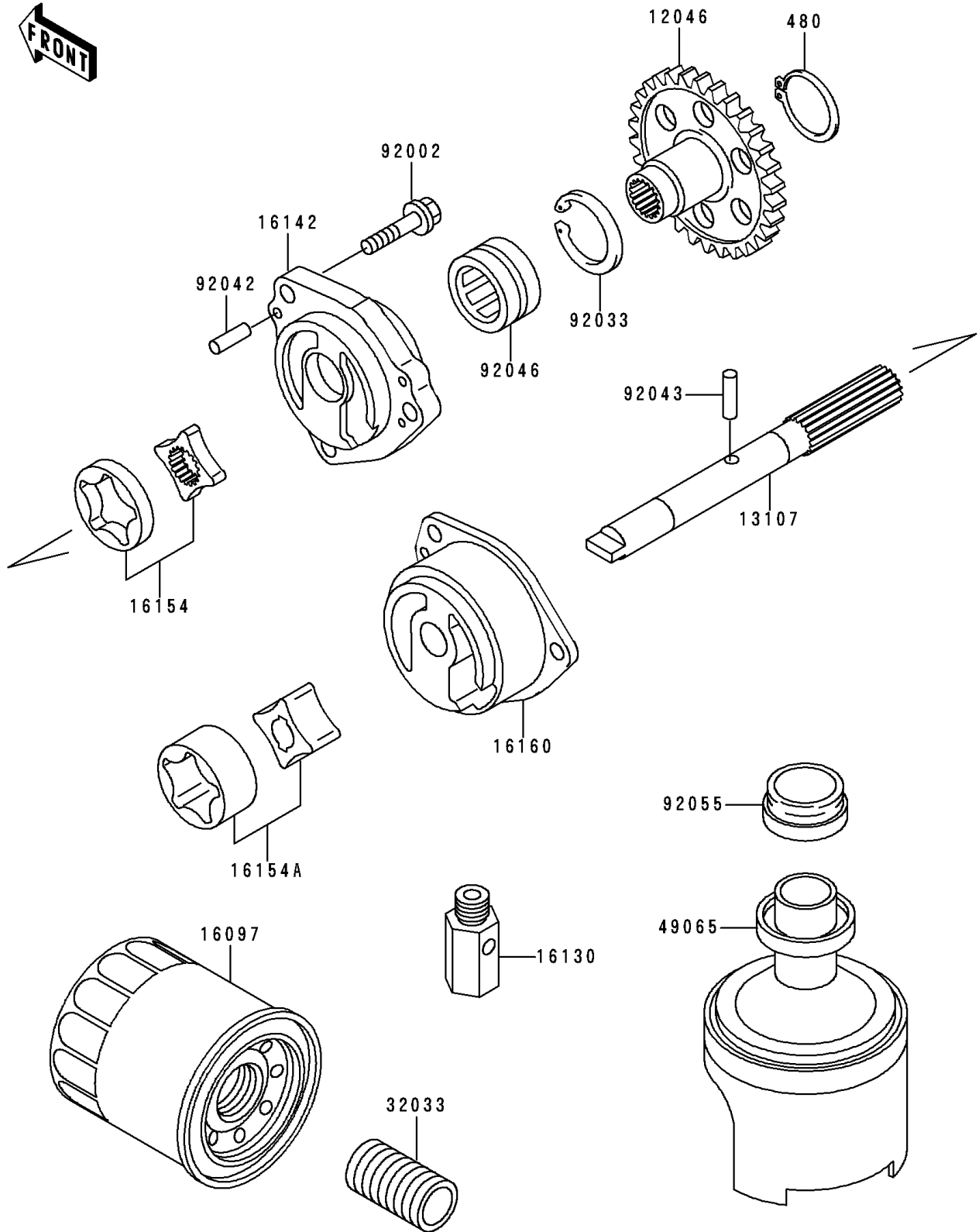

## 1996 Ninja® ZX™-9R PARTS LIST

### Oil Pump/Oil Filter

| ITEM NAME                            | PART NUMBER | QUANTITY |
|--------------------------------------|-------------|----------|
| CIRCLIP-TYPE-C,15MM (Ref # 480)      | 480J1500    | 1        |
| SPROCKET,OIL PUMP,30T (Ref # 12046)  | 12046-1123  | 1        |
| SHAFT,OIL PUMP (Ref # 13107)         | 13107-1278  | 1        |
| FILTER-ASSY-OIL (Ref # 16097)        | 16097-1063  | 1        |
| VALVE-ASSY-RELIEF (Ref # 16130)      | 16130-1001  | 2        |
| COVER-PUMP (Ref # 16142)             | 16142-1110  | 1        |
| ROTOR-PUMP (Ref # 16154)             | 16154-1090  | 1        |
| ROTOR-PUMP (Ref # 16154A)            | 16154-1107  | 1        |
| BODY,OIL PUMP (Ref # 16160)          | 16160-1229  | 1        |
| PIPE,OIL FILTER (Ref # 32033)        | 32033-1535  | 1        |
| FILTER-OIL (Ref # 49065)             | 49065-1068  | 1        |
| BOLT,6X25 (Ref # 92002)              | 92002-1582  | 3        |
| RING-SNAP (Ref # 92033)              | 92033-1277  | 1        |
| PIN,DOWEL,4X15.8 (Ref # 92042)       | 92042-014   | 1        |
| PIN,17.9X5.0 (Ref # 92043)           | 92043-1444  | 1        |
| BEARING-NEEDLE,RNA4903 (Ref # 92046) | 92046-1109  | 1        |
| RING-O,OIL FILTER (Ref # 92055)      | 92055-1503  | 1        |