

# 1995 Ninja® ZX™ -9R PARTS DIAGRAM

Rear Wheel/Chain

F2240

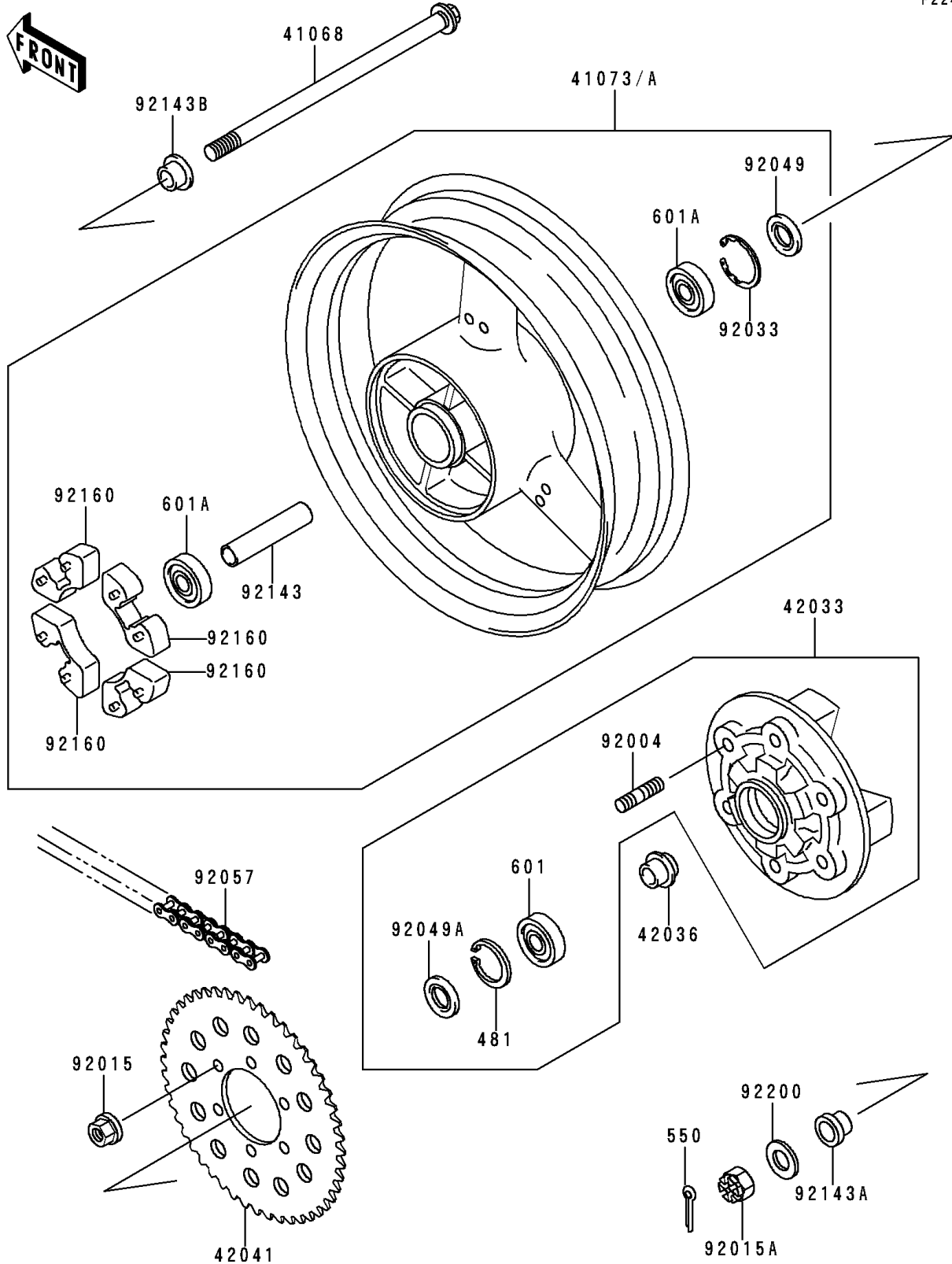

# 1995 Ninja® ZX™ -9R PARTS LIST

## Rear Wheel/Chain

ITEM NAME	PART NUMBER	QUANTITY
CIRCLIP (Ref # 481)	481J5500	1
PIN-COTTER,4.0X40 (Ref # 550)	550D4040	1
BEARING-BALL,#6006G (Ref # 601)	601B6006G	1
BEARING-BALL,#6205UG (Ref # 601A)	601B6205UG	2
AXLE,RR (Ref # 41068)	41068-1326	1
WHEEL-ASSY,RR,L.GREEN (Ref # 41073)	41073-1547-CJ	1
WHEEL-ASSY,RR,G.GRAY (Ref # 41073A)	41073-1547-GE	1
COUPLING-ASSY,RR HUB (Ref # 42033)	42033-1144	1
SLEEVE,RR HUB,L=22 (Ref # 42036)	42036-1279	1
SPROCKET-HUB,44T (Ref # 42041)	42041-1417	1
STUD,10X19.5 (Ref # 92004)	92004-1151	6
NUT,10MM (Ref # 92015)	92015-1720	6
NUT,CASTLE,24MM (Ref # 92015A)	92015-1844	1
RING-SNAP,52MM (Ref # 92033)	92033-1043	1
SEAL-OIL,BJN 32 52 5 (Ref # 92049)	92049-1375	1
SEAL-OIL,PJN 40 55 8 (Ref # 92049A)	92049-1376	1
CHAIN,DRIVE,EK50UV-XX112L (Ref # 92057)	92057-1385	1
COLLAR,RR HUB,L=133 (Ref # 92143)	92143-1473	1
COLLAR,RR AXLE,LH,L=20 (Ref # 92143A)	92143-1474	1
COLLAR,RR AXLE,RH,L=26 (Ref # 92143B)	92143-1475	1
DAMPER,SHOCK,RR HUB (Ref # 92160)	92160-1485	4
WASHER,25.5X38X4.5 (Ref # 92200)	92200-1081	1