

# 1997 Ninja® ZX™-9R PARTS DIAGRAM

Handlebar

F2310

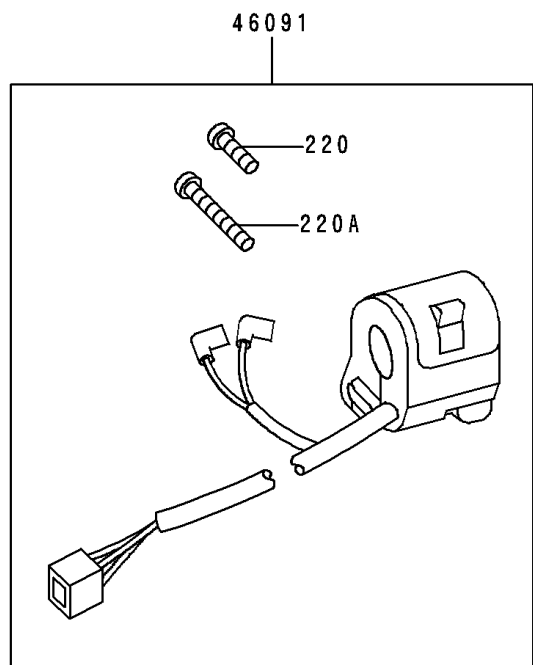
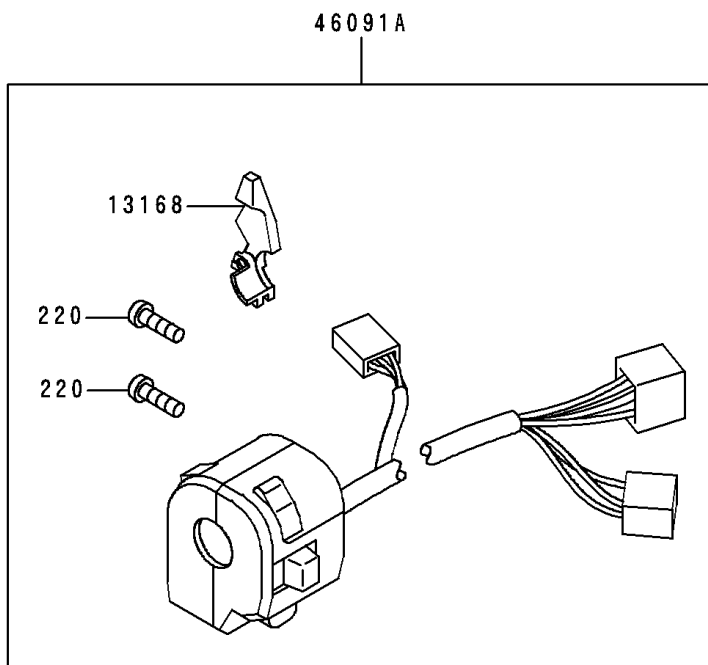
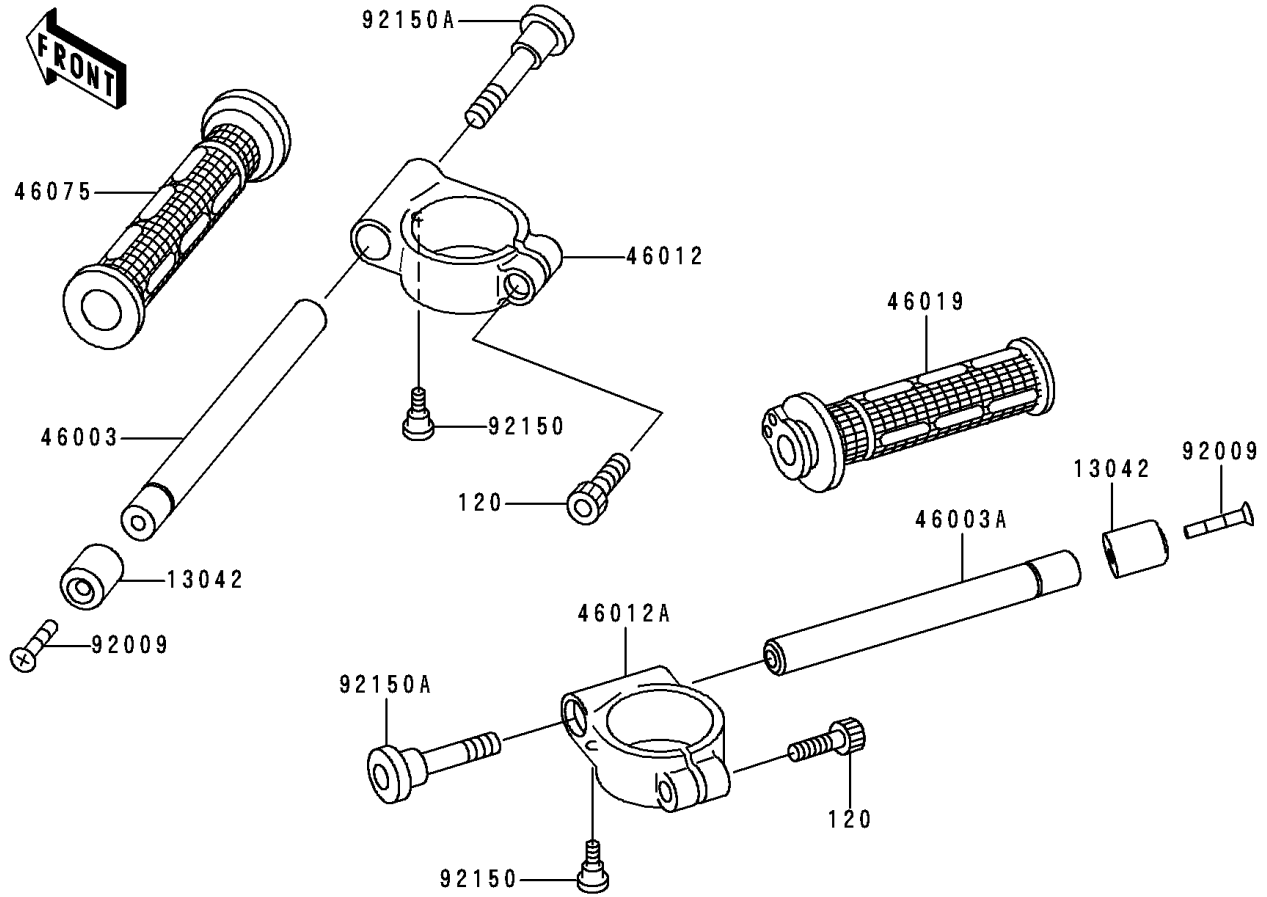

# 1997 Ninja® ZX™-9R PARTS LIST

## Handlebar

ITEM NAME	PART NUMBER	QUANTITY
BOLT-SOCKET,8X30 (Ref # 120)	120P0830	2
SCREW-PAN-CROS (Ref # 220)	220C0525	3
SCREW-PAN-CROS (Ref # 220A)	220C0540	1
WEIGHT,HANDLE (Ref # 13042)	13042-1069	2
LEVER,CHOKE (Ref # 13168)	13168-1516	1
HANDLE,LH (Ref # 46003)	46003-1388	1
HANDLE,RH (Ref # 46003A)	46003-1389	1
HOLDER-HANDLE,LH (Ref # 46012)	46012-1250	1
HOLDER-HANDLE,RH (Ref # 46012A)	46012-1251	1
GRIP-ASSY,THROTTLE (Ref # 46019)	46019-1077	1
GRIP,LH (Ref # 46075)	46075-1088	1
HOUSING-ASSY-CONTROL,RH (Ref # 46091)	46091-1663	1
HOUSING-ASSY-CONTROL,LH (Ref # 46091A)	46091-1664	1
SCREW,8X45 (Ref # 92009)	92009-1257	2
BOLT,6MM (Ref # 92150)	92150-1090	2
BOLT,SOCKET,10X37 (Ref # 92150A)	92150-1469	2