

1999 Ninja® ZX™-9R PARTS DIAGRAM

Oil Pump/Oil Filter

E1710

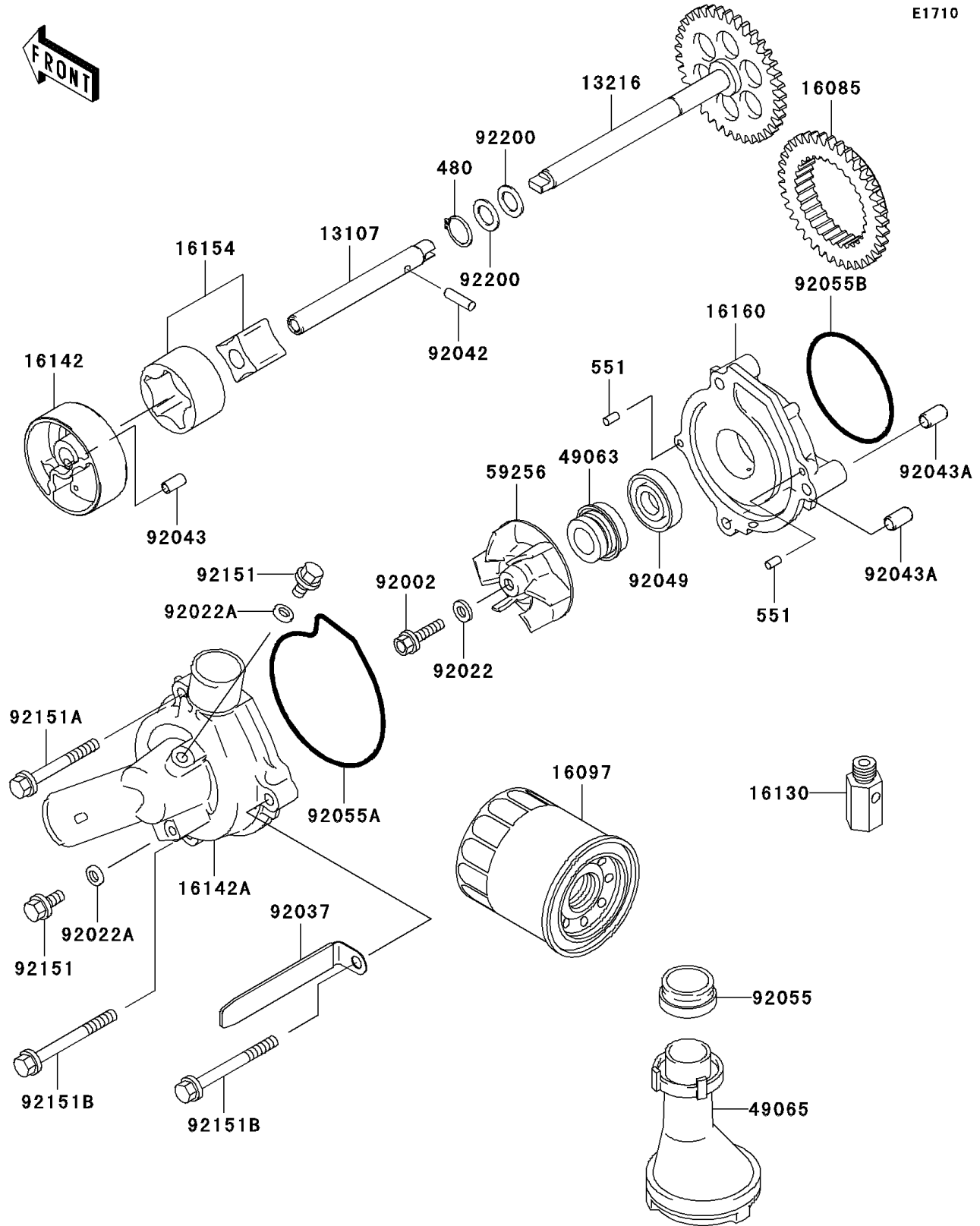

1999 Ninja® ZX™-9R PARTS LIST

Oil Pump/Oil Filter

ITEM NAME	PART NUMBER	QUANTITY
CIRCLIP-TYPE-C,11MM (Ref # 480)	480J1100	1
PIN-DOWEL,4X8 (Ref # 551)	551A0408	2
SHAFT,OIL PUMP (Ref # 13107)	13107-1378	1
GEAR-COMP,OIL PUMP (Ref # 13216)	13216-1168	1
GEAR,OIL PUMP,37T (Ref # 16085)	16085-1305	1
FILTER-ASSY-OIL (Ref # 16097)	16097-1067	1
VALVE-ASSY-RELIEF (Ref # 16130)	16130-1058	1
COVER-PUMP,OIL (Ref # 16142)	16142-1146	1
COVER-PUMP,WATER (Ref # 16142A)	16142-1147	1
ROTOR-PUMP (Ref # 16154)	16154-1115	1
BODY,OIL PUMP (Ref # 16160)	16160-1280	1
SEAL-MECHANICAL,WATER PUMP (Ref # 49063)	49063-1002	1
FILTER-OIL (Ref # 49065)	49065-1078	1
IMPELLER (Ref # 59256)	59256-1074	1
BOLT,6X22 (Ref # 92002)	92002-1154	1
WASHER,6.1X12X1 (Ref # 92022)	92022-077	1
WASHER,6.2X11X1 (Ref # 92022A)	92022-304	2
CLAMP (Ref # 92037)	92037-1679	1
PIN,DOWEL,4X15.8 (Ref # 92042)	92042-014	1
PIN,4.2X6X12 (Ref # 92043)	92043-1262	1
PIN,6.2X8X14 (Ref # 92043A)	92043-1263	2
SEAL-OIL,OIL PUMP (Ref # 92049)	92049-1336	1
RING-O,OIL FILTER (Ref # 92055)	92055-1503	1
RING-O,WATER PUMP COVER (Ref # 92055A)	92055-1571	1
RING-O (Ref # 92055B)	92055-3018	1
BOLT,6X12 (Ref # 92151)	92151-1133	2
BOLT,6X50 (Ref # 92151A)	92151-1234	1
BOLT,6X60 (Ref # 92151B)	92151-1235	2
WASHER (Ref # 92200)	92200-1009	2