

2003 Ninja® ZX™ -9R PARTS DIAGRAM

Crankshaft

E1321

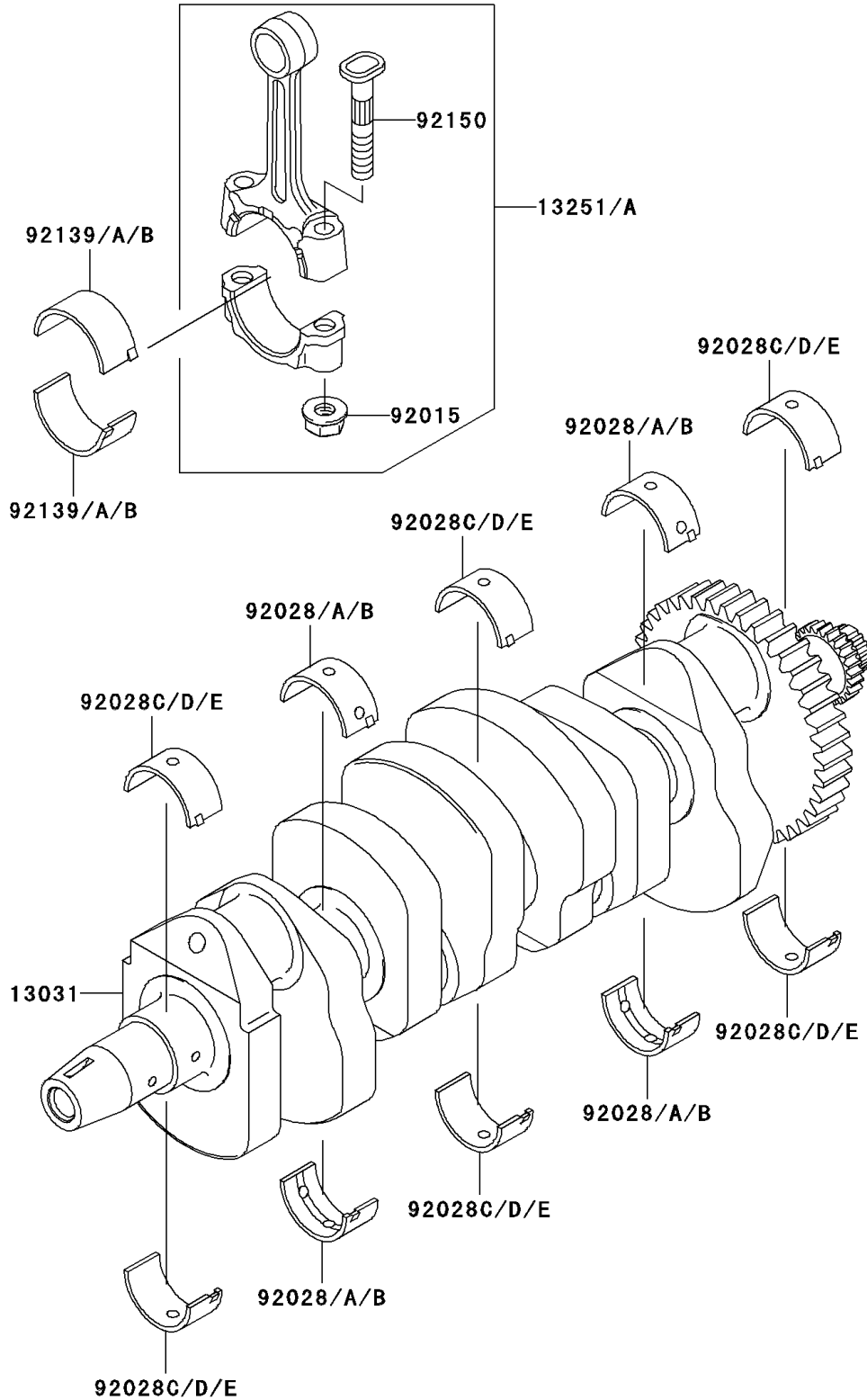

2003 Ninja® ZX™ -9R PARTS LIST

Crankshaft

ITEM NAME	PART NUMBER	QUANTITY
CRANKSHAFT-COMP (Ref # 13031)	13031-1502	1
ROD-ASSY-CONNECTING (Ref # 13251)	13251-1122-II	4
ROD-ASSY-CONNECTING,J (Ref # 13251A)	13251-1122-JJ	4
NUT,FLANGED,8MM (Ref # 92015)	92015-1311	8
BUSHING,CRANK,#2,#4,BLUE (Ref # 92028)	92028-1827	4
BUSHING,CRANK,#2,#4,BLACK (Ref # 92028A)	92028-1828	AR
BUSHING,CRANK,#2,#4,BROWN (Ref # 92028B)	92028-1829	AR
BUSHING,CRANK,#1,#3,#5,BLUE (Ref # 92028C)	92028-1866	6
BUSHING,CRANK,#1,#3,#5,BLACK (Ref # 92028D)	92028-1867	AR
BUSHING,CRANK,#1,#3,#5,BROWN (Ref # 92028E)	92028-1868	AR
BUSHING,CONNECTING ROD,BLUE (Ref # 92139)	92139-1097	8
BUSHING,CONNECTING ROD,BLACK (Ref # 92139A)	92139-1098	AR
BUSHING,CONNECTING ROD,BROWN (Ref # 92139B)	92139-1099	AR
BOLT,CONNECTING ROD,8MM (Ref # 92150)	92150-1216	8