

2003 Ninja® ZX™ -9R PARTS DIAGRAM

Seat

F2510

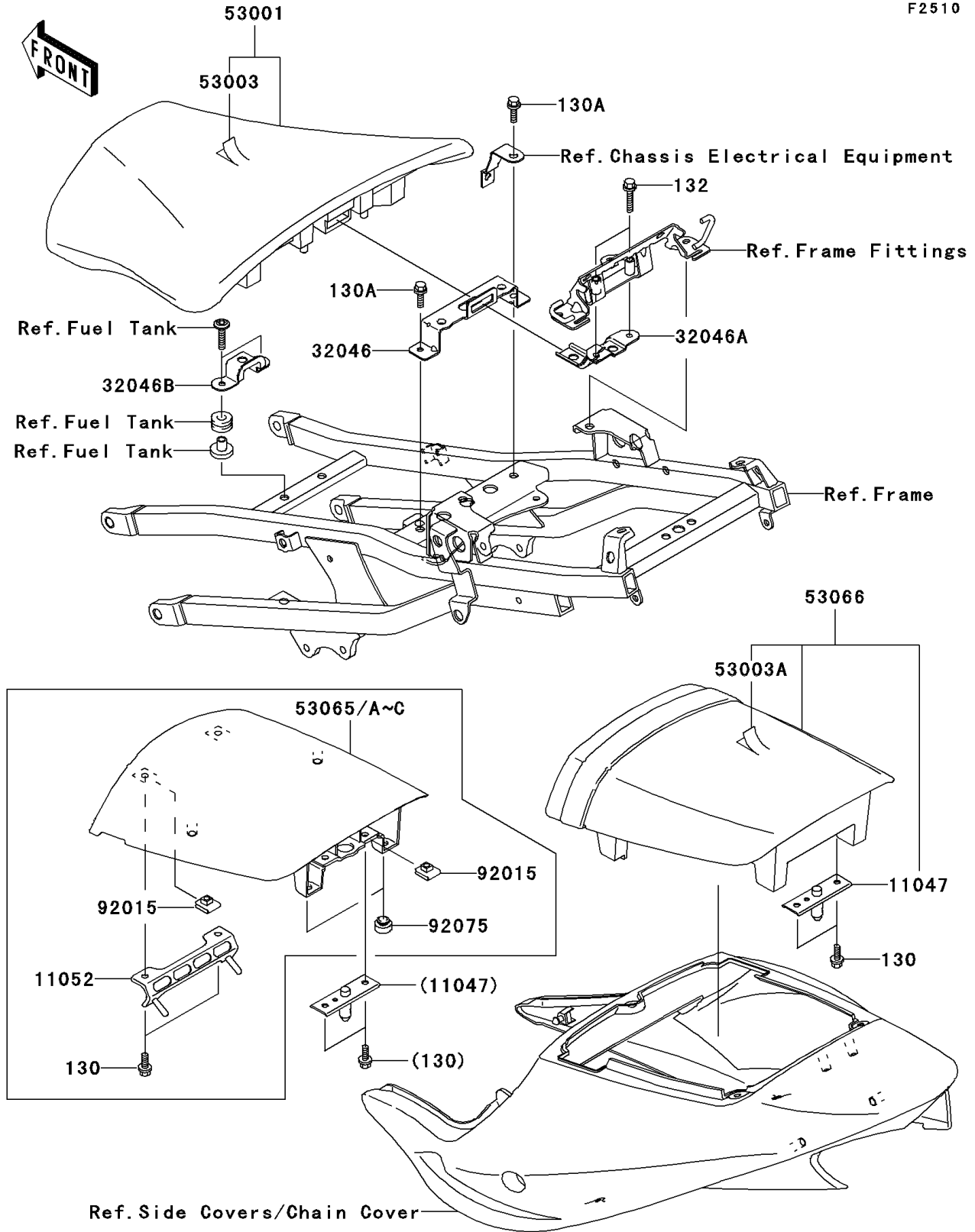

2003 Ninja® ZX™ -9R PARTS LIST

Seat

ITEM NAME	PART NUMBER	QUANTITY
BOLT-FLANGED,6X16,BLACK (Ref # 130)	130J0616	4
BOLT-FLANGED (Ref # 130A)	130J0620	2
BOLT-FLANGED-SMALL (Ref # 132)	132J0630	2
BRACKET,SEAT (Ref # 11047)	11047-1638	1
BRACKET,SEAT COVER (Ref # 11052)	11052-1887	1
BRACKET-SEAT,RR,LWR (Ref # 32046)	32046-1506	1
BRACKET-SEAT,RR,UPP (Ref # 32046A)	32046-1508	1
BRACKET-SEAT,FR (Ref # 32046B)	32046-1516	1
SEAT-ASSY,FR,BLACK (Ref # 53001)	53001-1981-MA	1
LEATHER,FRONT SEAT,BLACK (Ref # 53003)	53003-1493-MA	1
LEATHER,REAR SEAT,BLACK (Ref # 53003A)	53003-1494-MA	1
COVER SEAT,M.S.SILVER (Ref # 53065B)	53065-1053-474	1
COVER SEAT,L.GREEN (Ref # 53065C)	53065-1053-7F	1
SEAT-ASSY,RR,W/BAND,BLACK (Ref # 53066)	53066-1059-MA	1
NUT,CLAMP,6MM (Ref # 92015)	92015-1531	4
DAMPER (Ref # 92075)	92075-1598	2
COVER SEAT,M.C.BLUE (Ref # 53065A)	53065-1053-469	1