

# 1994 KDX200 PARTS DIAGRAM

Cylinder Head/Cylinder

E1110

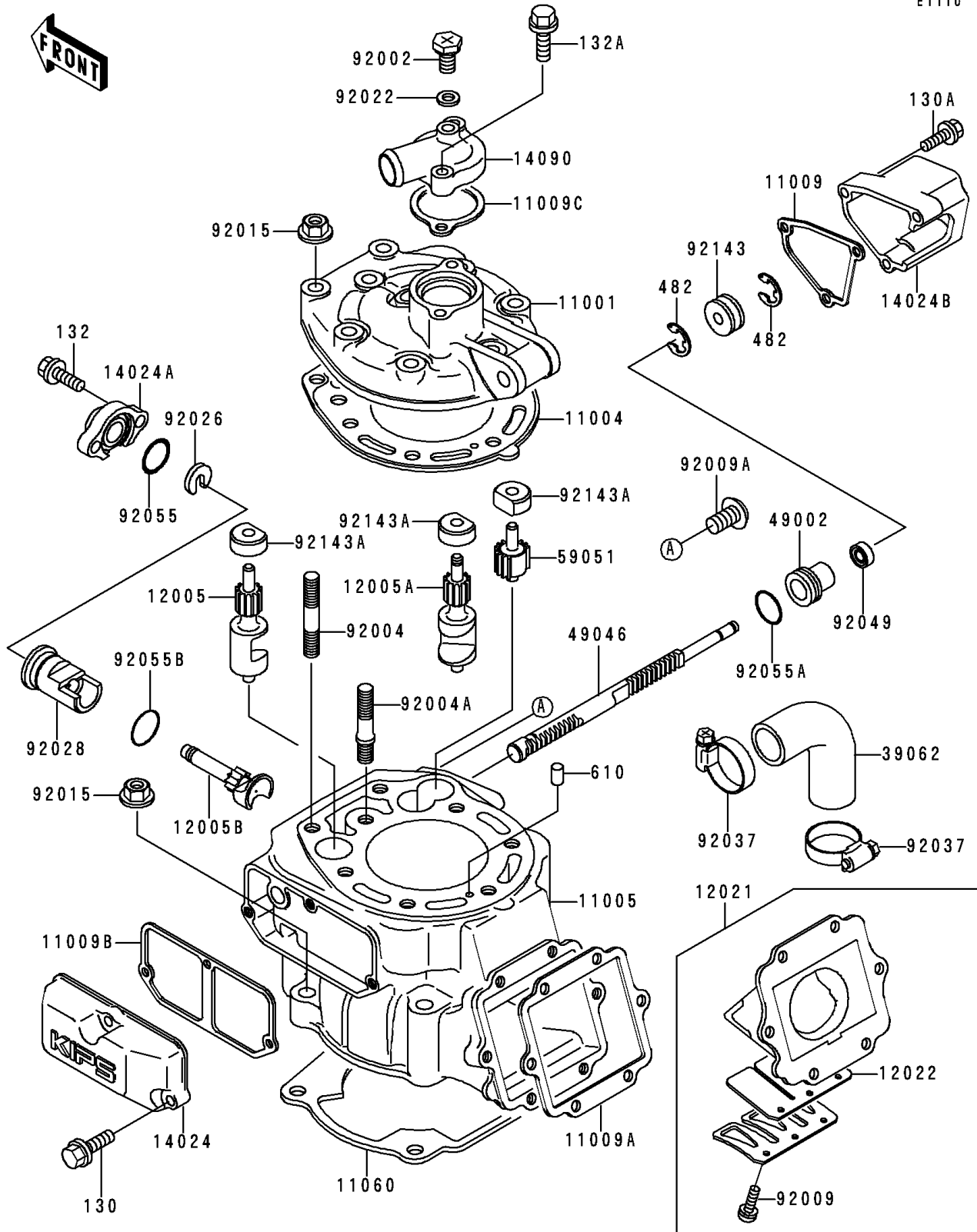

# 1994 KDX200 PARTS LIST

## Cylinder Head/Cylinder

ITEM NAME	PART NUMBER	QUANTITY
BOLT-FLANGED (Ref # 130)	130G0520	3
BOLT-FLANGED (Ref # 130A)	130G0525	3
BOLT-FLANGED-SMALL (Ref # 132)	132G0620	2
HEAD-CYLINDER (Ref # 11001)	11001-1317	1
GASKET-HEAD (Ref # 11004)	11004-1189	1
CYLINDER-ENGINE (Ref # 11005)	11005-1569	1
GASKET,RH,GOVERNOR (Ref # 11009)	11009-1934	1
GASKET,REED VALVE (Ref # 11009A)	11009-1941	1
GASKET,LH,RESONATOR (Ref # 11009B)	11009-1968	1
GASKET,ELBOW (Ref # 11009C)	11009-1993	1
GASKET,CYLINDER BASE (Ref # 11060)	11060-1659	1
VALVE-EXHAUST,LH (Ref # 12005)	12005-1121	1
VALVE-EXHAUST,RH (Ref # 12005A)	12005-1122	1
VALVE-EXHAUST,CENTER (Ref # 12005B)	12005-1157	1
VALVE-ASSY-REED (Ref # 12021)	12021-1067	1
VALVE-REED (Ref # 12022)	12022-1063	2
COVER,RESONATOR (Ref # 14024)	14024-1565	1
COVER,CENTER VALVE (Ref # 14024A)	14024-1708	1
COVER,GOVERNOR (Ref # 14024B)	14024-1786	1
COVER,THERMOSTAT (Ref # 14090)	14090-1534	1
HOSE-COOLING,PUMP-CYLINDER (Ref # 39062)	39062-1299	1
GUIDE-VALVE (Ref # 49002)	49002-1083	1
ROD-GOVERNOR (Ref # 49046)	49046-1069	1
GEAR-SPUR,IDLE (Ref # 59051)	59051-1206	1
BOLT,6X10 (Ref # 92002)	92002-1222	1
STUD,8X35 (Ref # 92004)	92004-1009	7
STUD,8X34 (Ref # 92004A)	92004-1199	1
SCREW,REED VALVE (Ref # 92009)	92009-1014	6
SCREW,5X10 (Ref # 92009A)	92009-1502	1

## 1994 KDX200 PARTS LIST

### Cylinder Head/Cylinder

ITEM NAME	PART NUMBER	QUANTITY
NUT,8MM (Ref # 92015)	92015-1143	12
WASHER,6.2X11X1 (Ref # 92022)	92022-304	1
SPACER (Ref # 92026)	92026-1333	1
BUSHING,CENTER VALVE (Ref # 92028)	92028-1616	1
CLAMP,COOLING HOSE (Ref # 92037)	92037-1589	2
SEAL-OIL,RSO-5.5X11X4 (Ref # 92049)	92049-1206	1
RING-O,16.8X2.4 (Ref # 92055)	92055-1258	1
RING-O,14.5X1.5 (Ref # 92055A)	92055-1399	1
RING-O (Ref # 92055B)	92055-1422	1
COLLAR (Ref # 92143)	92143-1056	1
COLLAR,VALVE (Ref # 92143A)	92143-1147	3
BOLT-FLANGED-SMALL (Ref # 132A)	132G0625	2
CIRCLIP-TYPE-E,4MM (Ref # 482)	482J4000	2
ROLLER,4X8 (Ref # 610)	610A0408	1