

# 1993 KDX200 PARTS DIAGRAM

Muffler(s)

E1140

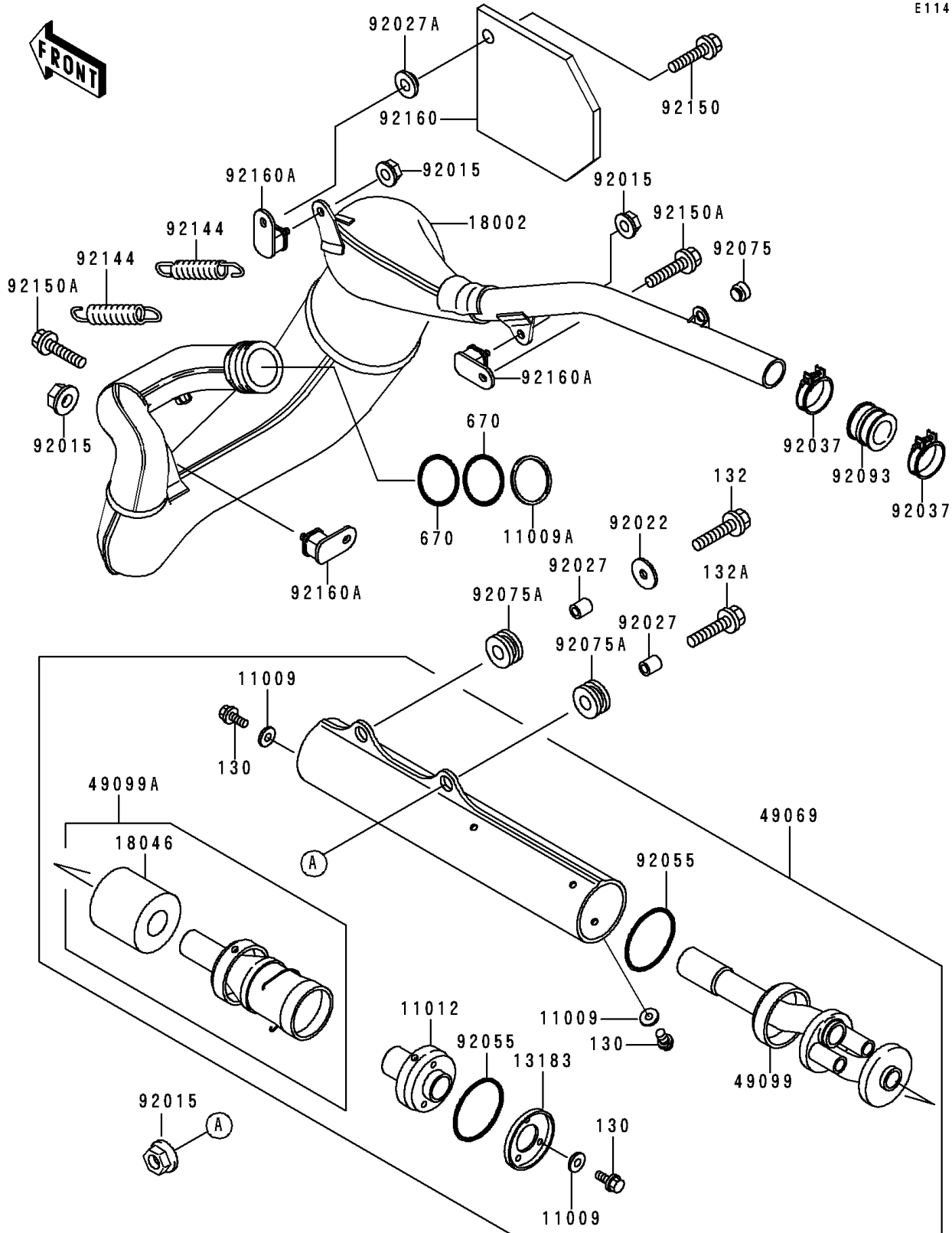

# 1993 KDX200 PARTS LIST

## Muffler(s)

ITEM NAME	PART NUMBER	QUANTITY
BOLT-FLANGED (Ref # 130)	130G0510	10
BOLT-FLANGED-SMALL (Ref # 132)	132G0625	1
BOLT-FLANGED-SMALL (Ref # 132A)	132G0630	1
O RING,39MM (Ref # 670)	670E3039	2
GASKET,5.5X13X1.2 (Ref # 11009)	11009-1881	10
GASKET,EXHAUST PIPE (Ref # 11009A)	11009-1995	1
CAP,TAIL PIPE (Ref # 11012)	11012-1739	1
PLATE,TAIL PIPE (Ref # 13183)	13183-1569	1
BODY-COMP-MUFFLER (Ref # 18002)	18002-1933	1
WOOL,BAFFLE PIPE (Ref # 18046)	18046-1115	1
MUFFLER-ASSY (Ref # 49069)	49069-1137	1
BAFFLE-PIPE MUFFLER,FR (Ref # 49099)	49099-1286	1
BAFFLE-PIPE MUFFLER,RR (Ref # 49099A)	49099-1287	1
NUT,FLANGED,6MM (Ref # 92015)	92015-1078	4
WASHER,6.5X22X1.6 (Ref # 92022)	92022-237	1
COLLAR,6.8X10X11.5 (Ref # 92027)	92027-1210	2
COLLAR,L=5.6 (Ref # 92027A)	92027-1933	1
CLAMP,40MM (Ref # 92037)	92037-1129	2
RING-O,61.6X3.5 (Ref # 92055)	92055-1431	2
DAMPER (Ref # 92075)	92075-1598	2
DAMPER,MUFFLER FITTING (Ref # 92075A)	92075-1857	2
SEAL,MUFFLER (Ref # 92093)	92093-1085	1
SPRING (Ref # 92144)	92144-1035	2
BOLT,6X20 (Ref # 92150)	92150-1339	1
BOLT,6X14 (Ref # 92150A)	92150-1340	2
DAMPER,HEAT (Ref # 92160)	92160-1145	1
DAMPER,MUFFLER,FR (Ref # 92160A)	92160-1176	3