

1993 KDX200 PARTS DIAGRAM

Crankshaft/Piston(s)

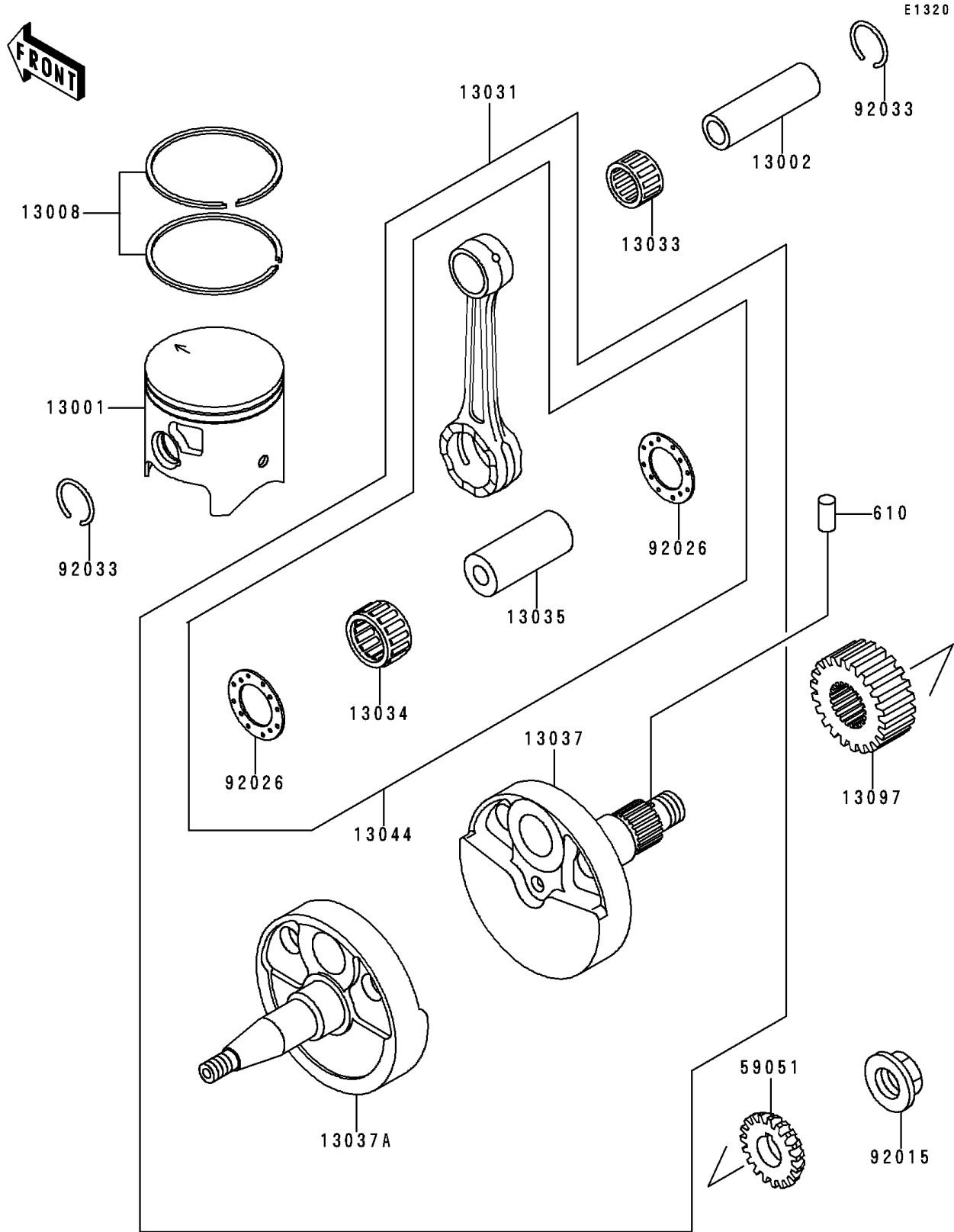

1993 KDX200 PARTS LIST

Crankshaft/Piston(s)

ITEM NAME	PART NUMBER	QUANTITY
ROLLER,4X8 (Ref # 610)	610A0408	1
PISTON-ENGINE (Ref # 13001)	13001-1317	1
PIN-PISTON (Ref # 13002)	13002-1053	1
RING-SET-PISTON (Ref # 13008)	13008-1116	1
CRANKSHAFT-COMP (Ref # 13031)	13031-1300	1
BEARING-SMALL END (Ref # 13033)	13033-1056	1
BEARING-BIG END,B4 (Ref # 13034)	13034-1081	1
PIN-CRANK (Ref # 13035)	13035-1010	1
CRANKSHAFT,RH (Ref # 13037)	13037-1361	1
CRANKSHAFT,LH (Ref # 13037A)	13037-1382	1
SET-CONNECTING ROD (Ref # 13044)	13044-5071	1
GEAR-PRIMARY SPUR,22T (Ref # 13097)	13097-1157	1
GEAR-SPUR,WATER PUMP (Ref # 59051)	59051-1207	1
NUT (Ref # 92015)	92015-1581	1
SPACER,22.5X37X1.0 (Ref # 92026)	92026-011	2
RING-SNAP,PISTON PIN (Ref # 92033)	92033-1242	2