

1988 Tecate 4 PARTS DIAGRAM

Gear Change Mechanism

E1370-0181

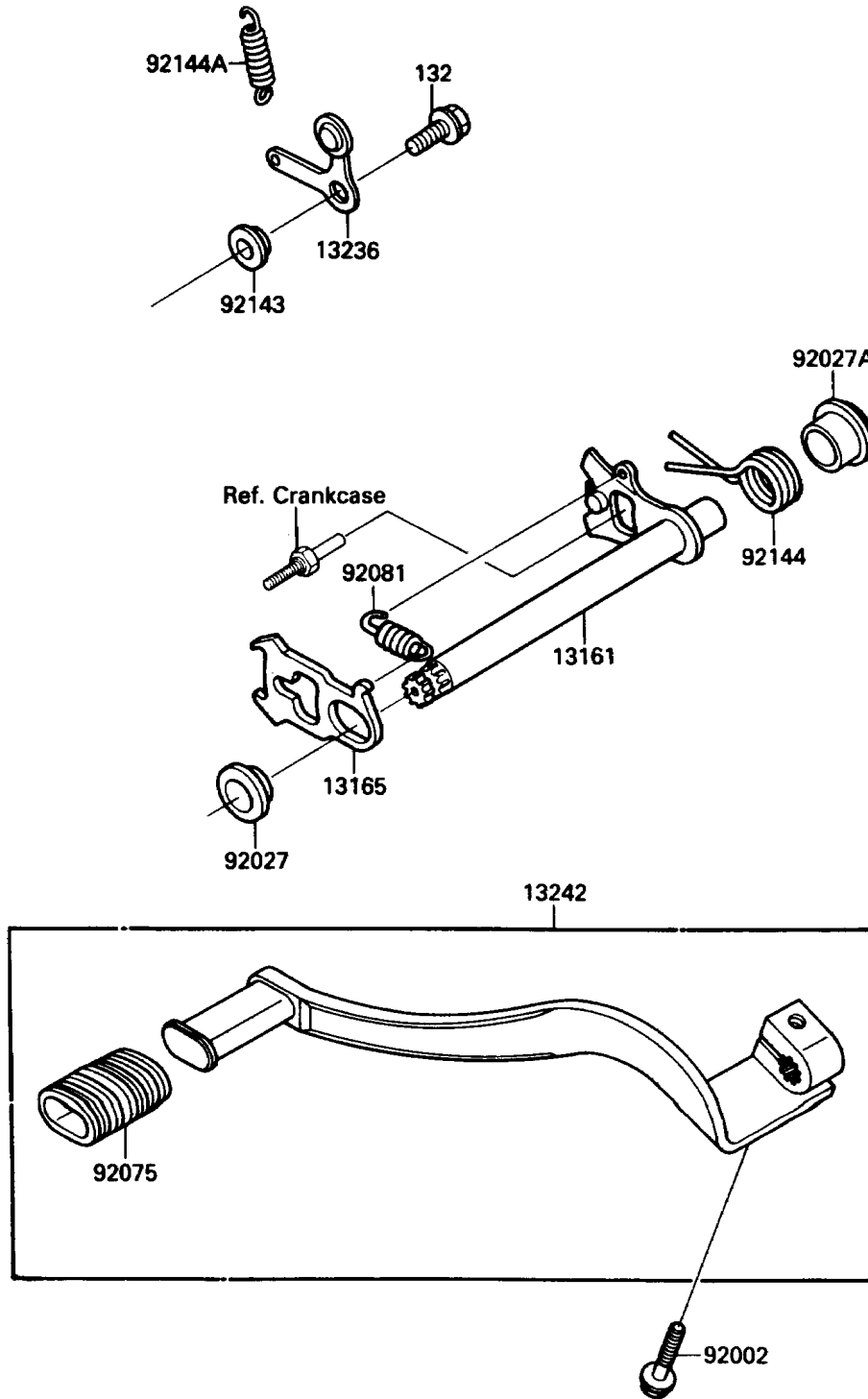

1988 Tecate 4 PARTS LIST

Gear Change Mechanism

ITEM NAME	PART NUMBER	QUANTITY
LEVER-COMP-CHANGE SHAFT (Ref # 13161)	13161-1143	1
PAWL,CHANGE LEVER (Ref # 13165)	13165-1122	1
LEVER-COMP,POSITION (Ref # 13236)	13236-1155	1
LEVER-ASSY-CHANGE,PEDAL (Ref # 13242)	13242-1230	1
BOLT,6X25 (Ref # 92002)	92002-1339	1
COLLAR,CHANGE SHAFT,L=5.5 (Ref # 92027)	92027-1512	1
COLLAR (Ref # 92027A)	92027-1940	1
DAMPER,CHANGE PEDAL (Ref # 92075)	92075-1585	1
SPRING,CHANGE LEVER (Ref # 92081)	92081-076	1
COLLAR (Ref # 92143)	92143-1055	1
SPRING,CHANGE SHAFT RETURN (Ref # 92144)	92144-1142	1
SPRING,POSITION LEVER (Ref # 92144A)	92144-1182	1
BOLT-FLANGED-SMALL (Ref # 132)	132G0616	1