

# 2005 Vulcan 1600 Classic PARTS DIAGRAM

## Gear Change Mechanism

E1370

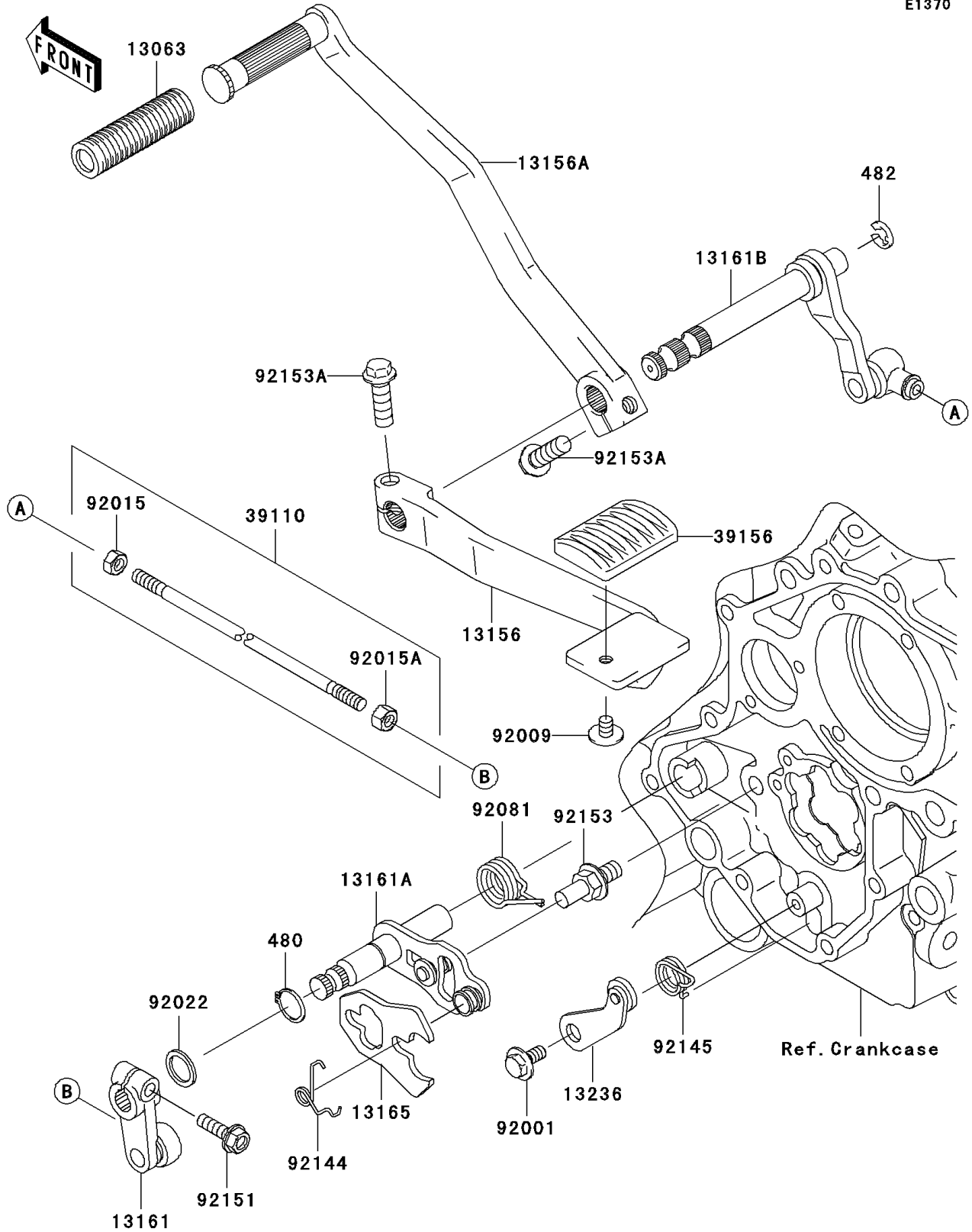

## 2005 Vulcan 1600 Classic PARTS LIST

### Gear Change Mechanism

ITEM NAME	PART NUMBER	QUANTITY
CIRCLIP-TYPE-C,13MM (Ref # 480)	480J1300	1
CIRCLIP-TYPE-E,10MM (Ref # 482)	482L0100	1
DAMPER,PEDAL (Ref # 13063)	13063-002	1
LEVER-CHANGE,PEDAL,RR (Ref # 13156)	13156-0019	1
LEVER-CHANGE,PEDAL,FR (Ref # 13156A)	13156-0026	1
LEVER-COMP-CHANGE SHAFT (Ref # 13161)	13161-1253	1
LEVER-COMP-CHANGE SHAFT (Ref # 13161A)	13161-1254	1
LEVER-COMP-CHANGE SHAFT (Ref # 13161B)	13161-1294	1
PAWL (Ref # 13165)	13165-1120	1
LEVER-COMP,POSITION (Ref # 13236)	13236-1126	1
ROD-ASSY-TIE (Ref # 39110)	39110-1119	1
PAD (Ref # 39156)	39156-1641	1
BOLT,FLANGED,M6X14 (Ref # 92001)	92001-1715	1
SCREW,6X8 (Ref # 92009)	92009-1677	1
NUT,6MM (Ref # 92015)	92015-1443	1
NUT,LEFT HANDED,6MM (Ref # 92015A)	92015-1444	1
WASHER,13.2X20X0.5 (Ref # 92022)	92022-1224	1
SPRING,CHANGE PEDAL RETURN (Ref # 92081)	92081-1869	1
SPRING (Ref # 92144)	92144-1029	1
SPRING,RETURN (Ref # 92145)	92145-0008	1
BOLT,FLANGED,M6X20 (Ref # 92151)	92151-1226	1
BOLT,RETURN SPRING (Ref # 92153)	92153-1076	1
BOLT,8X25 (Ref # 92153A)	92153-1268	2