

2005 Vulcan 1600 Nomad PARTS DIAGRAM

Tires

F2210

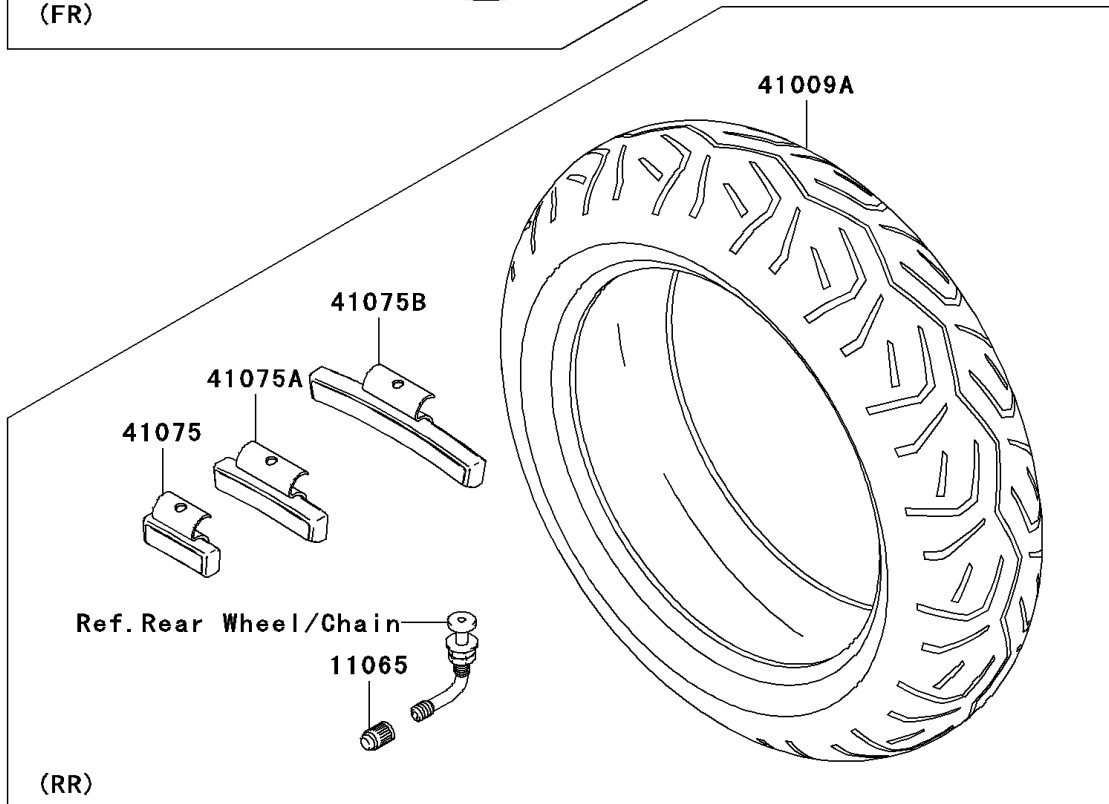
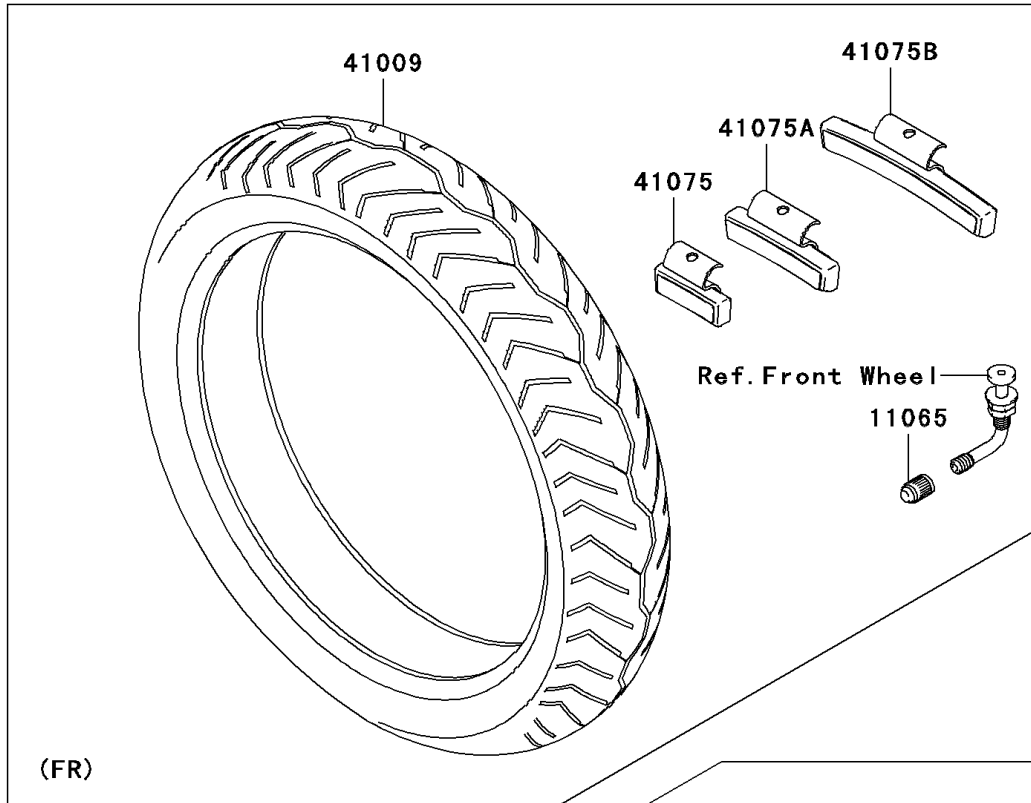

2005 Vulcan 1600 Nomad PARTS LIST

Tires

ITEM NAME	PART NUMBER	QUANTITY
CAP (Ref # 11065)	11065-1112	2
TIRE,FR,150/80-16 71H,G721(BS) (Ref # 41009)	41009-0056	1
TIRE,RR,170/70B16 75H,G722G(BS (Ref # 41009A)	41009-0089	1
BALANCER-WHEEL,10G,SILVER (Ref # 41075)	41075-0014	AR
BALANCER-WHEEL,20G,SILVER (Ref # 41075A)	41075-0015	AR
BALANCER-WHEEL,30G,SILVER (Ref # 41075B)	41075-0016	AR