

2005 Vulcan 1600 Nomad PARTS DIAGRAM

Handlebar

F2310

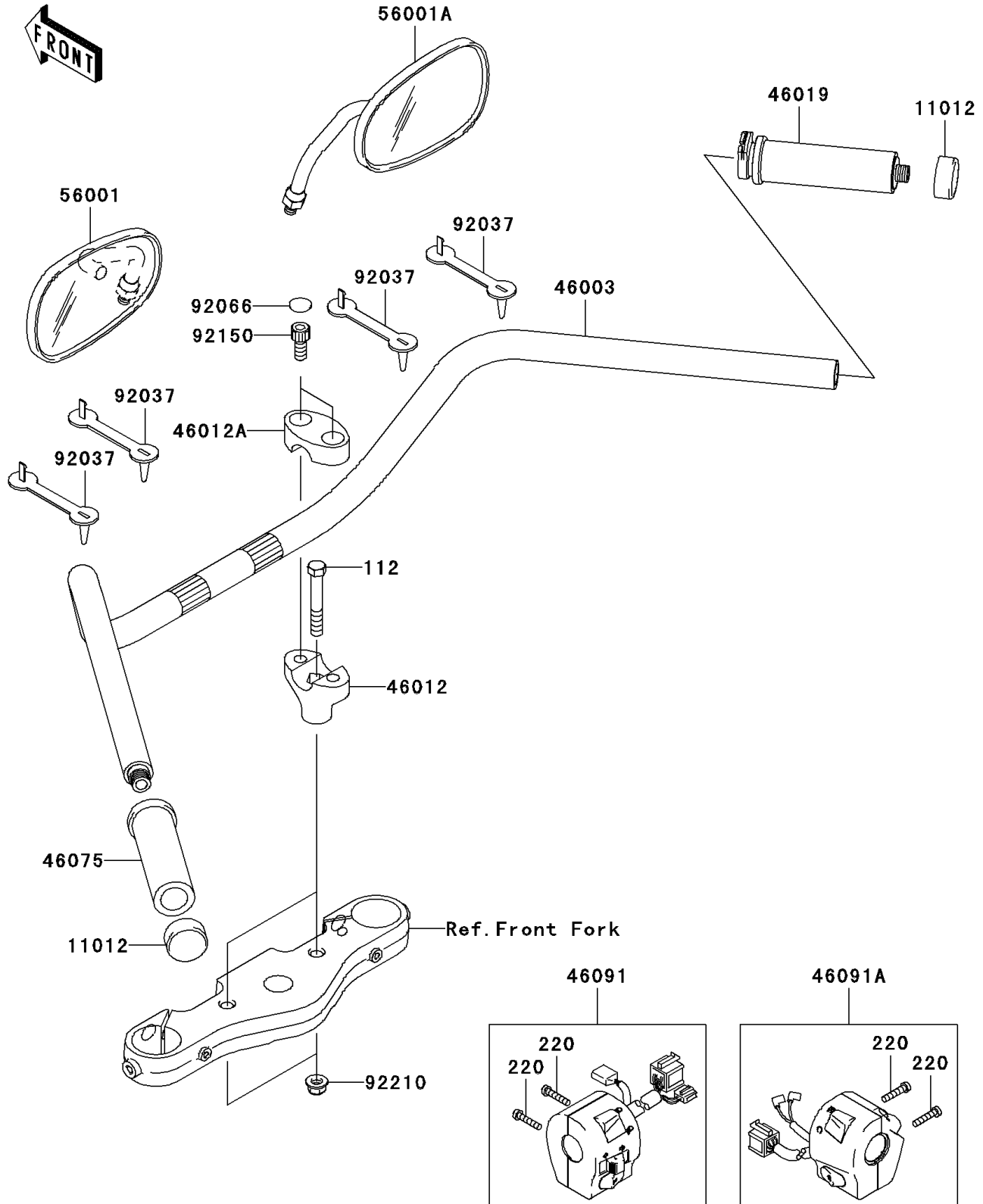

2005 Vulcan 1600 Nomad PARTS LIST

Handlebar

ITEM NAME	PART NUMBER	QUANTITY
BOLT-UPSET,10X65 (Ref # 112)	112H1065	2
SCREW-PAN-CROSS,5X25 (Ref # 220)	220R0525	4
CAP,GRIP END (Ref # 11012)	11012-1975	2
HANDLE (Ref # 46003)	46003-0074	1
HOLDER-HANDLE,LWR (Ref # 46012)	46012-1272	2
HOLDER-HANDLE,UPP (Ref # 46012A)	46012-1273	2
GRIP-ASSY,THROTTLE (Ref # 46019)	46019-1109	1
GRIP,LH (Ref # 46075)	46075-1074	1
HOUSING-ASSY-CONTROL,LH (Ref # 46091)	46091-0018	1
HOUSING-ASSY-CONTROL,RH (Ref # 46091A)	46091-0019	1
MIRROR-ASSY,LH (Ref # 56001)	56001-1592	1
MIRROR-ASSY,RH (Ref # 56001A)	56001-1593	1
CLAMP,SPEED,L=80.5 (Ref # 92037)	92037-1903	4
PLUG (Ref # 92066)	92066-1285	4
BOLT,SOCKET,10X23 (Ref # 92150)	92150-1942	4
NUT,LOCK,FLANGED,10MM (Ref # 92210)	92210-1139	2