

1990 Ninja® ZX™-6 PARTS DIAGRAM

Rear Caliper

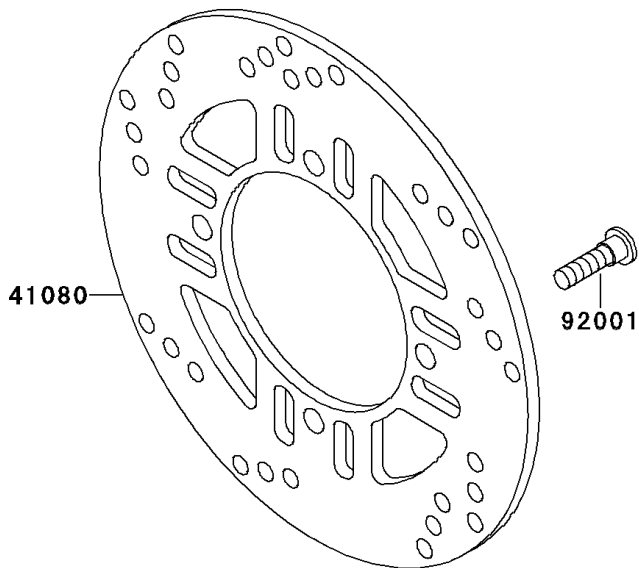
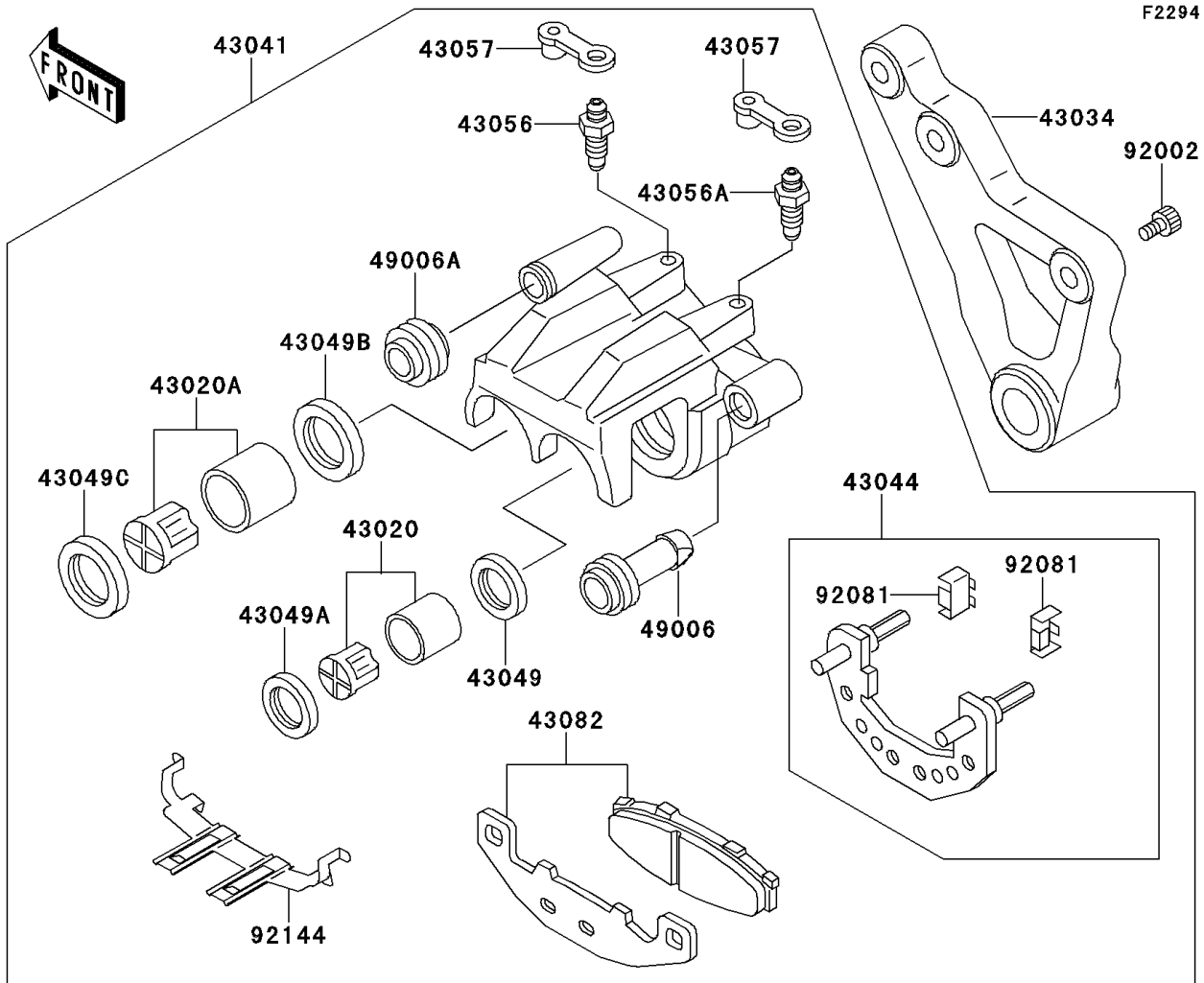

1990 Ninja® ZX™-6 PARTS LIST

Rear Caliper

ITEM NAME	PART NUMBER	QUANTITY
DISC,RR,SILVER NO.1 (Ref # 41080)	41080-1177-CM	1
PISTON-COMP-BRAKE (Ref # 43020)	43020-1068	1
PISTON-COMP-BRAKE (Ref # 43020A)	43020-1069	1
HOLDER-BRAKE,REAR CALIPER (Ref # 43034)	43034-1103	1
CALIPER-ASSY,RR,M.F.GRAY (Ref # 43041)	43041-1362-FE	1
HOLDER-COMP-CALIPER (Ref # 43044)	43044-1067	1
PACKING,PISTON SEAL (Ref # 43049)	43049-1054	1
PACKING,PISTON (Ref # 43049A)	43049-1055	1
PACKING,PISTON SEAL (Ref # 43049B)	43049-1056	1
PACKING,PISTON (Ref # 43049C)	43049-1057	1
BREATHER (Ref # 43056)	43056-003	1
BREATHER-BRAKE (Ref # 43056A)	43056-1054	1
CAP-BREATHER (Ref # 43057)	43057-003	2
PAD-ASSY-BRAKE (Ref # 43082)	43082-1077	1
BOOT,CALIPER (Ref # 49006)	49006-1094	1
BOOT,CALIPER (Ref # 49006A)	49006-1095	1
BOLT,DISC PLATE,8X30 (Ref # 92001)	92001-1951	4
BOLT,SOCKET,10X17 (Ref # 92002)	92002-1713	2
SPRING,PAD STOPPER (Ref # 92081)	92081-1661	2
SPRING,PAD (Ref # 92144)	92144-1070	1