

2006 KX85 PARTS DIAGRAM

Shock Absorber(s)

F2280

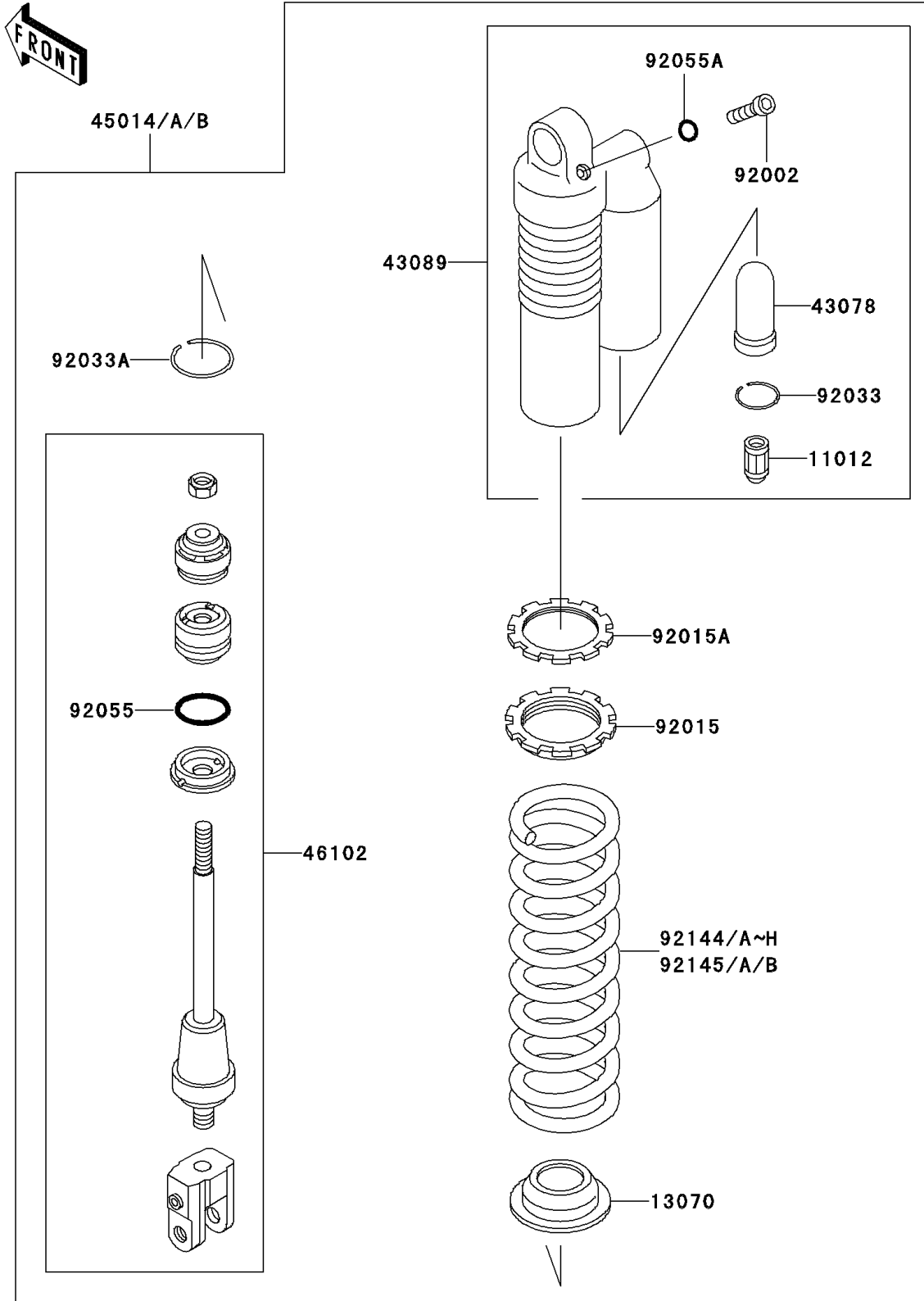

2006 KX85 PARTS LIST

Shock Absorber(s)

ITEM NAME	PART NUMBER	QUANTITY
CAP,VALVE AIR (Ref # 11012)	11012-1391	1
GUIDE,SPRING (Ref # 13070)	13070-1233	1
RESERVOIR,SHOCKABSORBER (Ref # 43078)	43078-1112	1
CYLINDER-SHOCKABSORBER,GOLD (Ref # 43089)	43089-0008-829	1
SHOCKABSORBER (Ref # 45014)	45014-5013	1
ROD,SHOCKABSORBER (Ref # 46102)	46102-1411	1
BOLT,DRAIN (Ref # 92002)	92002-1955	1
NUT,SPRING ADJUST (Ref # 92015)	92015-1679	1
NUT,SPRING ADJUST LOCK (Ref # 92015A)	92015-1713	1
RING-SNAP,REARSHOCK (Ref # 92033)	92033-1091	1
RING-SNAP,SHOCKABSORBER (Ref # 92033A)	92033-1211	1
RING-O,ROD (Ref # 92055)	92055-1334	1
RING-O (Ref # 92055A)	92055-1383	1
SPRING,SHOCK,K=45.0N/MM,SIL (Ref # 92144B)	92144-1570-8V	1
SPRING,SHOCK,K=49.0N/MM,SIL (Ref # 92144E)	92144-1571-8V	1
SPRING,SHOCK,K=47.0N/MM,SIL (Ref # 92144H)	92144-1945-8V	1
SPRING,SHOCK,K=43.1N/MM,SIL (Ref # 92145B)	92145-1371-8V	1