

2007 KFX700 PARTS DIAGRAM

Front Bevel Gear

E3131

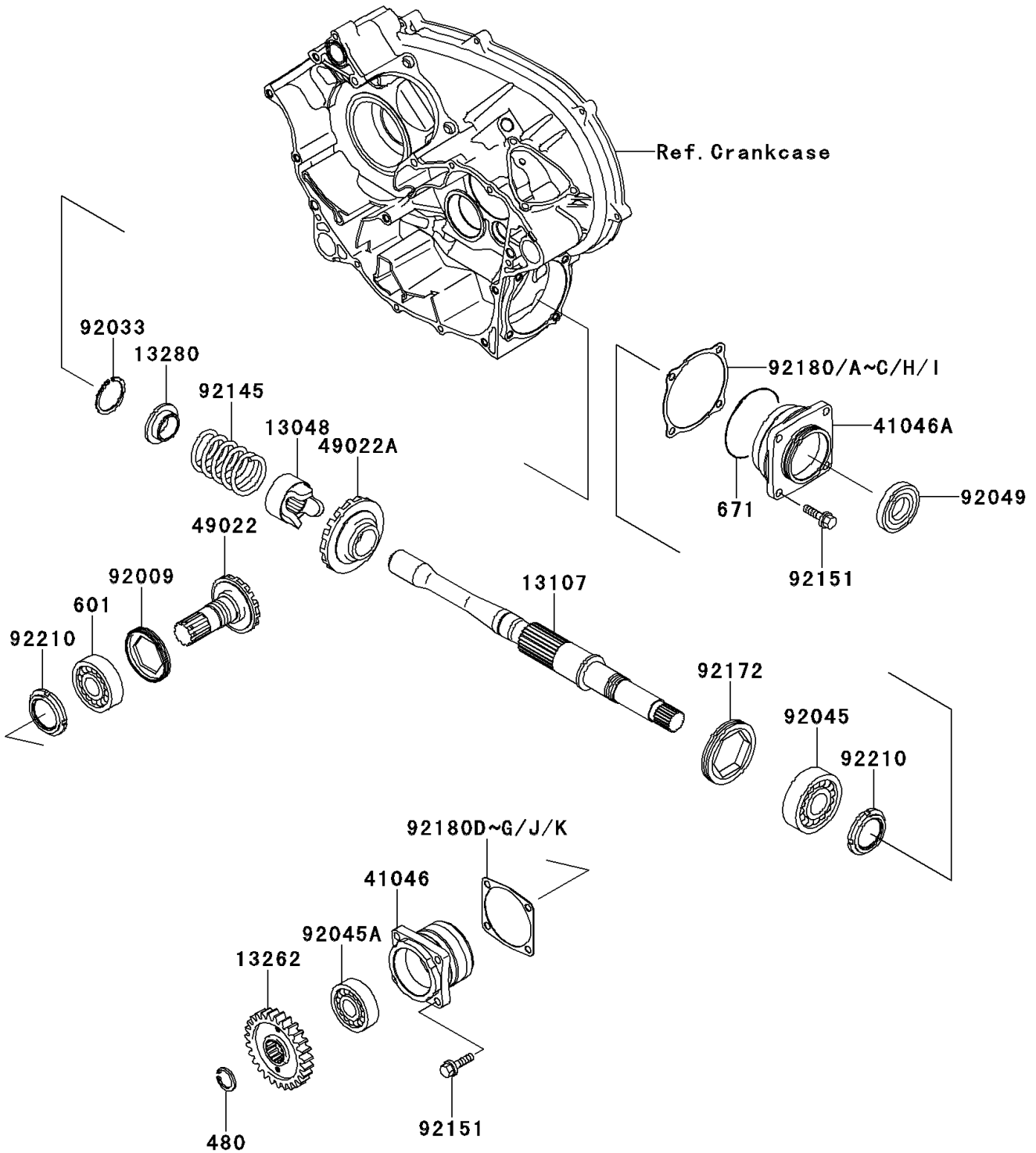

2007 KFX700 PARTS LIST

Front Bevel Gear

ITEM NAME	PART NUMBER	QUANTITY
CIRCLIP-TYPE-C,28MM (Ref # 480)	480J2800	1
BEARING-BALL,#6206C3 (Ref # 601)	601B6206	1
O RING (Ref # 671)	671D2585	1
CAM-DAMPER (Ref # 13048)	13048-1088	1
SHAFT (Ref # 13107)	13107-1516	1
GEAR,OUTPUT DRIVEN,27T (Ref # 13262)	13262-0014	1
HOLDER (Ref # 13280)	13280-1169	1
HOUSING-BEARING (Ref # 41046)	41046-1101	1
HOUSING-BEARING (Ref # 41046A)	41046-1102	1
GEAR-BEVEL,DRIVE,12T (Ref # 49022)	49022-1192	1
GEAR-BEVEL,DRIVEN,20T (Ref # 49022A)	49022-1193	1
SCREW,64MM (Ref # 92009)	92009-1914	1
RING-SNAP (Ref # 92033)	92033-1320	1
BEARING-BALL,6306SH2 (Ref # 92045)	92045-1190	1
BEARING-BALL,62/28 (Ref # 92045A)	92045-1207	1
SEAL-OIL (Ref # 92049)	92049-0095	1
SPRING (Ref # 92145)	92145-1298	1
BOLT-FLANGED-SMALL,8X30 (Ref # 92151)	92151-1688	8
SCREW,SET,75X10 (Ref # 92172)	92172-0371	1
SHIM,DRIVEN,T=0.15 (Ref # 92180)	92180-1307	AR
SHIM,DRIVEN,T=0.20 (Ref # 92180A)	92180-1308	AR
SHIM,DRIVEN,T=0.50 (Ref # 92180B)	92180-1309	AR
SHIM,DRIVEN,T=0.80 (Ref # 92180C)	92180-1310	AR
SHIM,DRIVE,T=0.15 (Ref # 92180D)	92180-1311	AR
SHIM,DRIVE,T=0.20 (Ref # 92180E)	92180-1312	AR
SHIM,DRIVE,T=0.50 (Ref # 92180F)	92180-1313	AR
SHIM,DRIVE,T=0.80 (Ref # 92180G)	92180-1314	AR
SHIM,DRIVEN,T=1.00 (Ref # 92180H)	92180-1349	AR
SHIM,DRIVEN,T=1.20 (Ref # 92180I)	92180-1350	AR

2007 KFX700 PARTS LIST

Front Bevel Gear

ITEM NAME	PART NUMBER	QUANTITY
SHIM,DRIVE,T=1.00 (Ref # 92180J)	92180-1351	AR
SHIM,DRIVE,T=1.20 (Ref # 92180K)	92180-1352	AR
NUT,30MM (Ref # 92210)	92210-1294	2