

2009 KFX® 450R PARTS DIAGRAM

Gear Change Mechanism

E1370

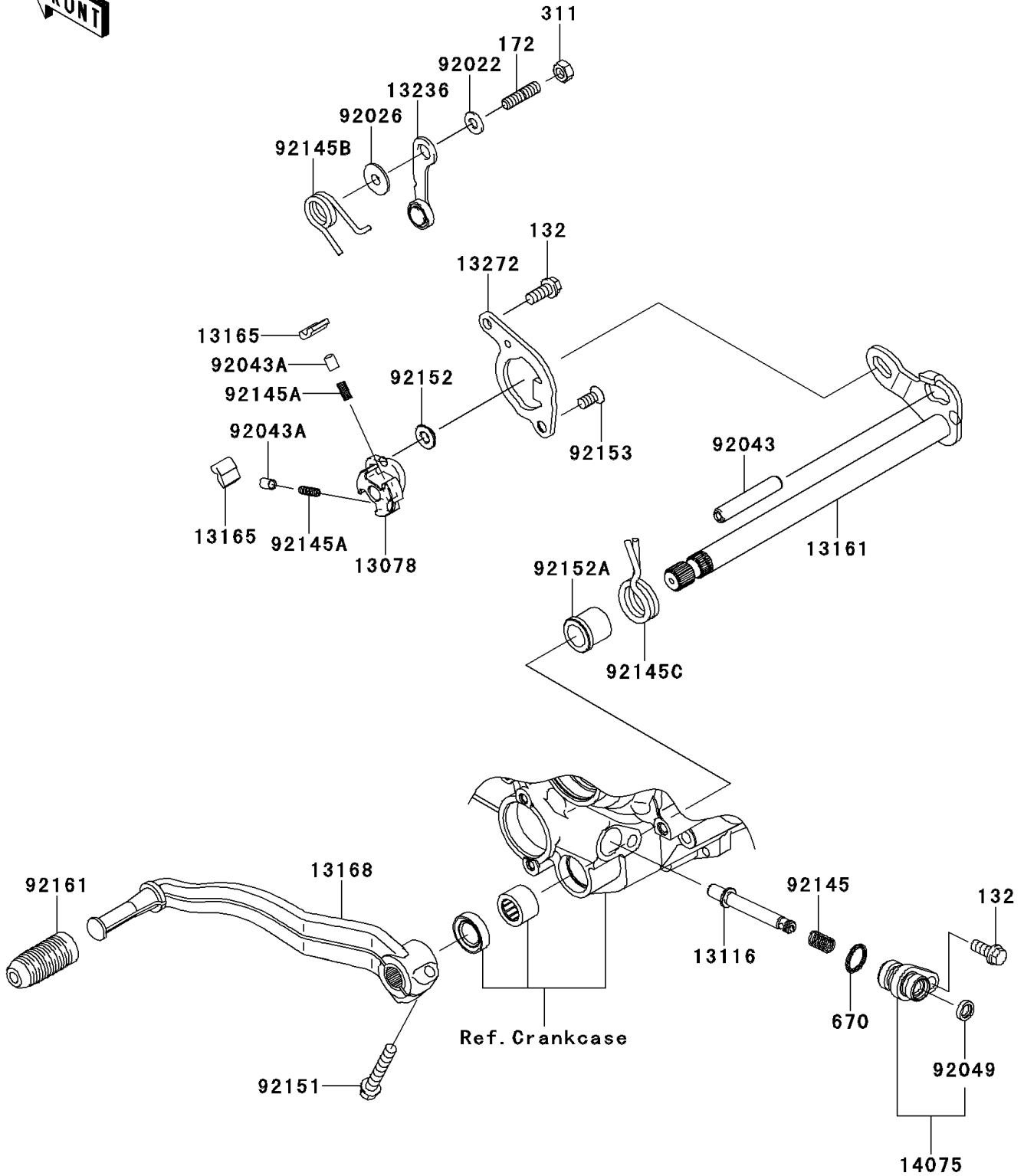

2009 KFX® 450R PARTS LIST

Gear Change Mechanism

ITEM NAME	PART NUMBER	QUANTITY
BOLT-FLANGED-SMALL,6X14 (Ref # 132)	132BD0614	2
BOLT-STUD,6X12 (Ref # 172)	172BA0612	1
NUT-HEX (Ref # 311)	311BA0600	1
O RING,12MM (Ref # 670)	670B2012	1
RATCHET (Ref # 13078)	13078-0012	1
ROD-PUSH (Ref # 13116)	13116-0024	1
LEVER-COMP-CHANGE SHAFT (Ref # 13161)	13161-0055	1
PAWL (Ref # 13165)	13165-0017	2
LEVER (Ref # 13168)	13168-0162	1
LEVER-COMP,POSITION (Ref # 13236)	13236-0129	1
PLATE (Ref # 13272)	13272-0073	1
CAP-ASSY (Ref # 14075)	14075-0005	1
WASHER,6X12.8X1.2 (Ref # 92022)	92022-1827	1
SPACER (Ref # 92026)	92026-1217	1
PIN,8X45 (Ref # 92043)	92043-0140	1
PIN,PLUNGER (Ref # 92043A)	92043-1676	2
SEAL-OIL,6.6X11X2.5 (Ref # 92049)	92049-0094	1
SPRING,23.6MM (Ref # 92145)	92145-0397	1
SPRING (Ref # 92145A)	92145-0453	2
SPRING (Ref # 92145B)	92145-0457	1
SPRING,RETURN (Ref # 92145C)	92145-1493	1
BOLT,FLANGED-SMALL,6X25 (Ref # 92151)	92151-1930	1
COLLAR (Ref # 92152)	92152-1414	1
COLLAR,RETURN SPRING (Ref # 92152A)	92152-1419	1
BOLT,6X15 (Ref # 92153)	92153-0848	1
DAMPER (Ref # 92161)	92161-0359	1