

# 2009 KFX® 450R PARTS DIAGRAM

Engine Cover(s)

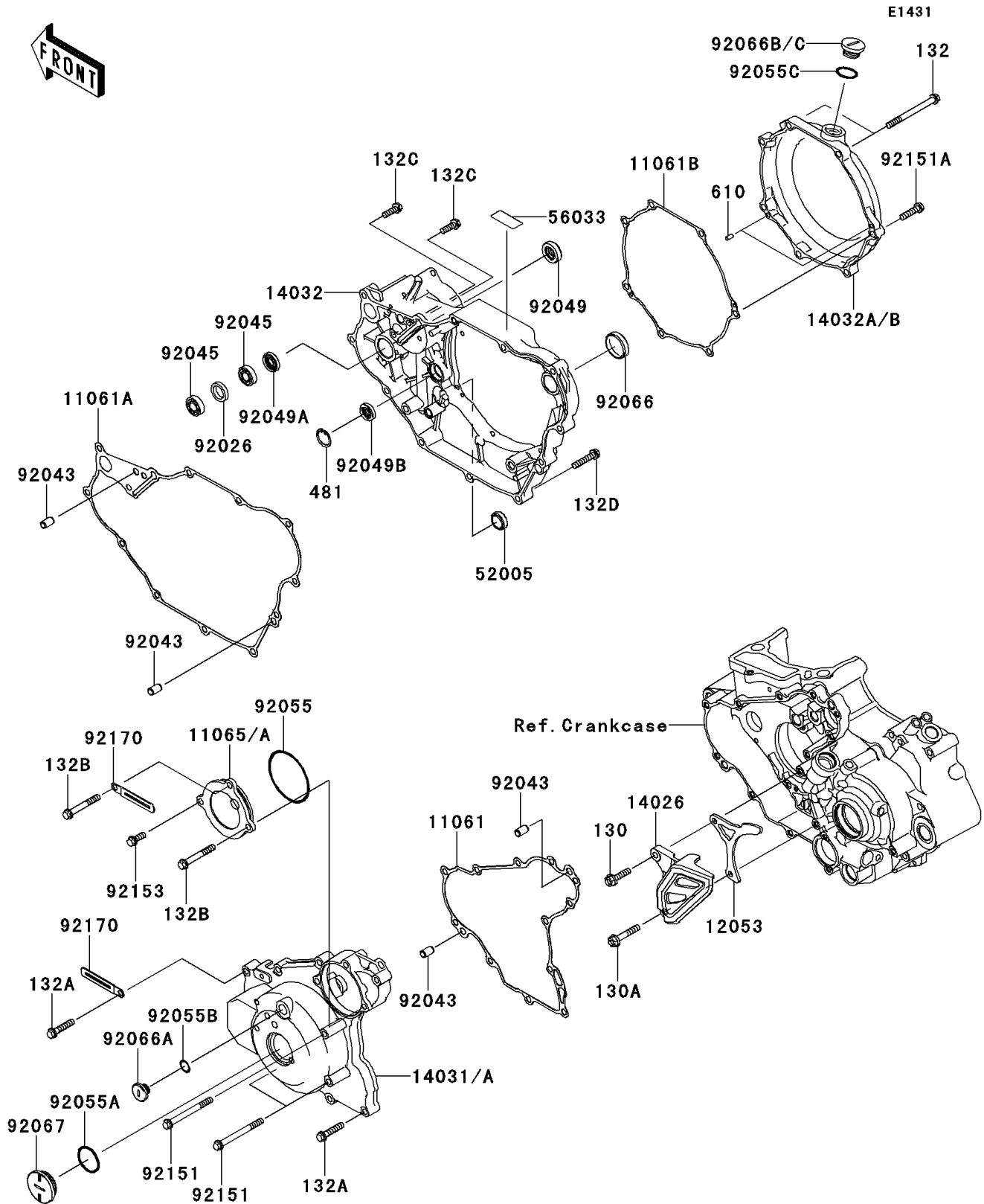

## 2009 KFX® 450R PARTS LIST

### Engine Cover(s)

ITEM NAME	PART NUMBER	QUANTITY
BOLT-FLANGED,6X25 (Ref # 130)	130BB0625	1
BOLT-FLANGED,6X35 (Ref # 130A)	130BB0635	1
BOLT-FLANGED-SMALL,6X18 (Ref # 132)	132BA0618	2
BOLT-FLANGED-SMALL,6X30 (Ref # 132A)	132BC0630	7
BOLT-FLANGED-SMALL,6X45 (Ref # 132B)	132BC0645	2
BOLT-FLANGED-SMALL,6X70 (Ref # 132C)	132BC0670	2
BOLT-FLANGED-SMALL,6X30 (Ref # 132D)	132BD0630	9
GASKET,GENERATOR COVER (Ref # 11061)	11061-0235	1
GASKET,CLUTCH COVER (Ref # 11061A)	11061-0236	1
GASKET,CLUTCH OUTER COVER (Ref # 11061B)	11061-0259	1
CAP,STARTER LIMITER (Ref # 11065A)	11065-0224	1
GUIDE-CHAIN (Ref # 12053)	12053-0081	1
COVER-CHAIN (Ref # 14026)	14026-0035	1
COVER-GENERATOR (Ref # 14031A)	14031-0085	1
COVER-CLUTCH (Ref # 14032)	14032-0083	1
COVER-CLUTCH,OUTER (Ref # 14032B)	14032-0103	1
GAUGE,OIL LEVEL (Ref # 52005)	52005-0019	1
LABEL-MANUAL,OIL CAPACITY (Ref # 56033)	56033-0200	1
SPACER,16X22X4.3 (Ref # 92026)	92026-0064	1
PIN,8X14 (Ref # 92043)	92043-0130	4
BEARING-BALL,6900C3 (Ref # 92045)	92045-0039	2
SEAL-OIL,12X24X7 (Ref # 92049)	92049-0040	1
SEAL-OIL,12X22X5 (Ref # 92049A)	92049-0041	1
SEAL-OIL,10X20X5 (Ref # 92049B)	92049-1542	1
RING-O,58X2.5 (Ref # 92055)	92055-0110	1
RING-O,27.7X2.4 (Ref # 92055A)	92055-091	1
RING-O,ID=13.8 (Ref # 92055B)	92055-1141	1
RING-O,20X2 (Ref # 92055C)	92055-1146	1
PLUG,KICK STARTER (Ref # 92066)	92066-0075	1

## 2009 KFX® 450R PARTS LIST

### Engine Cover(s)

ITEM NAME	PART NUMBER	QUANTITY
PLUG,12X8 (Ref # 92066A)	92066-0092	1
PLUG,18X9 (Ref # 92066B)	92066-0103	1
PLUG,30X8 (Ref # 92067)	92067-024	1
BOLT,6X65 (Ref # 92151)	92151-1199	3
BOLT,FLANGED-SMALL,6X25 (Ref # 92151A)	92151-1930	5
BOLT,6X16 (Ref # 92153)	92153-0695	1
CLAMP (Ref # 92170)	92170-1514	2
CIRCLIP-TYPE-C,20MM (Ref # 481)	481J2000	1
ROLLER,4X8 (Ref # 610)	610A0408	2