

# 2010 KFX® 450R PARTS DIAGRAM

Oil Pump

E1712

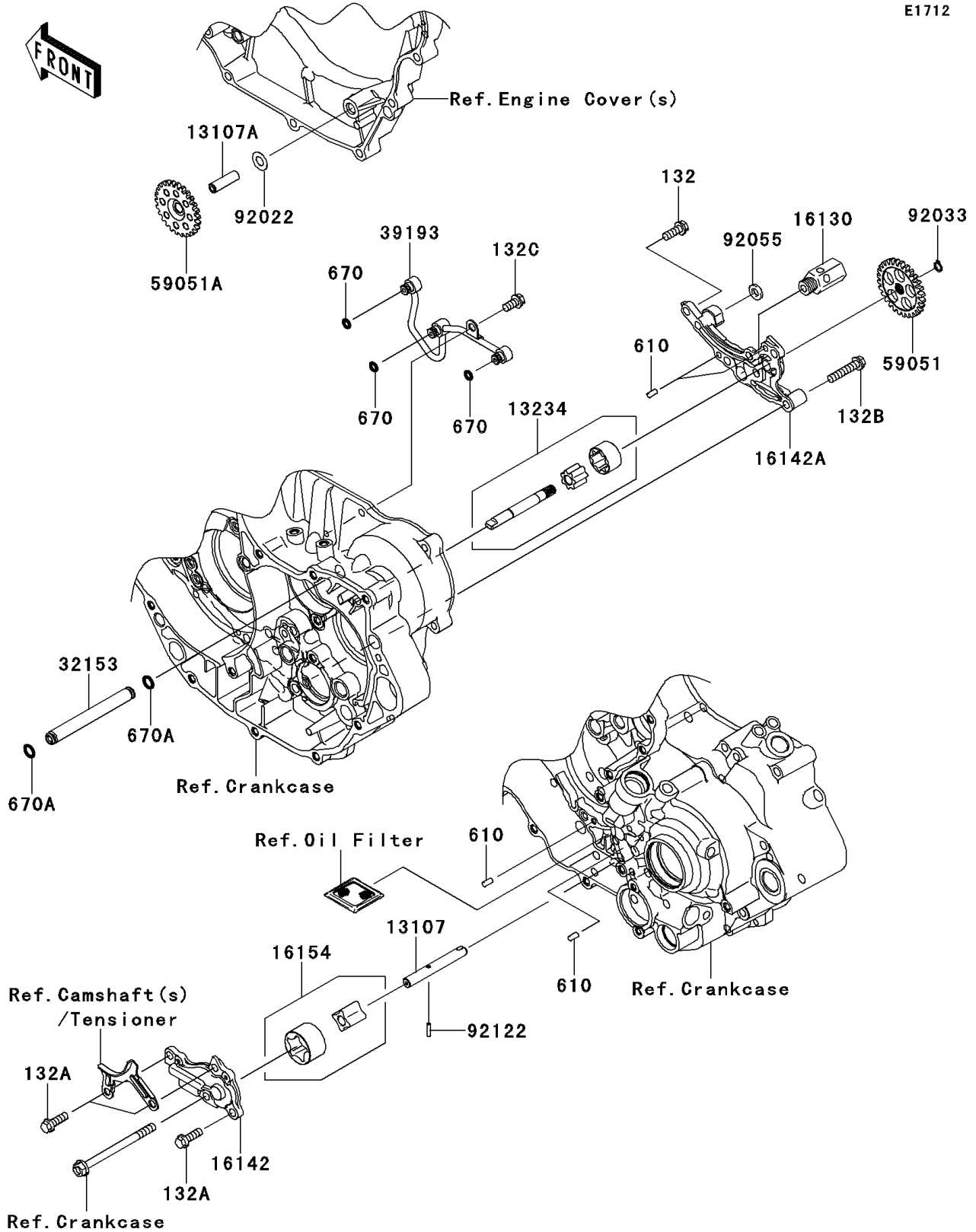

## 2010 KFX® 450R PARTS LIST

### Oil Pump

ITEM NAME	PART NUMBER	QUANTITY
BOLT-FLANGED-SMALL,6X16 (Ref # 132)	132BA0616	5
BOLT-FLANGED-SMALL,6X18 (Ref # 132A)	132BA0618	3
BOLT-FLANGED-SMALL,6X30 (Ref # 132B)	132BA0630	1
BOLT-FLANGED-SMALL,6X12 (Ref # 132C)	132BB0612	1
ROLLER,4X8 (Ref # 610)	610A0408	4
O RING (Ref # 670)	670D1505	3
O RING,7MM (Ref # 670A)	670D1507	2
SHAFT,OIL PUMP,SCAVENGE (Ref # 13107)	13107-0134	1
SHAFT,O/P IDLE (Ref # 13107A)	13107-0138	1
SHAFT-COMP,OIL PUMP,FEED (Ref # 13234)	13234-0029	1
VALVE-ASSY-RELIEF (Ref # 16130)	16130-1058	1
COVER-PUMP (Ref # 16142)	16142-0032	1
COVER-PUMP (Ref # 16142A)	16142-0033	1
ROTOR-PUMP,SCAVENGE (Ref # 16154)	16154-0069	1
PIPE (Ref # 32153)	32153-1189	1
PIPE-OIL (Ref # 39193)	39193-0038	1
GEAR-SPUR,O/P DRIVEN,28T (Ref # 59051)	59051-0044	1
GEAR-SPUR,O/P IDLE,26T (Ref # 59051A)	59051-0073	1
WASHER,8X16X0.5 (Ref # 92022)	92022-1475	1
RING-SNAP (Ref # 92033)	92033-0019	1
RING-O,OD=13 (Ref # 92055)	92055-074	1
ROLLER,2.5X11.8 (Ref # 92122)	92122-0021	1