

2009 KFX® 450R PARTS DIAGRAM

Swingarm

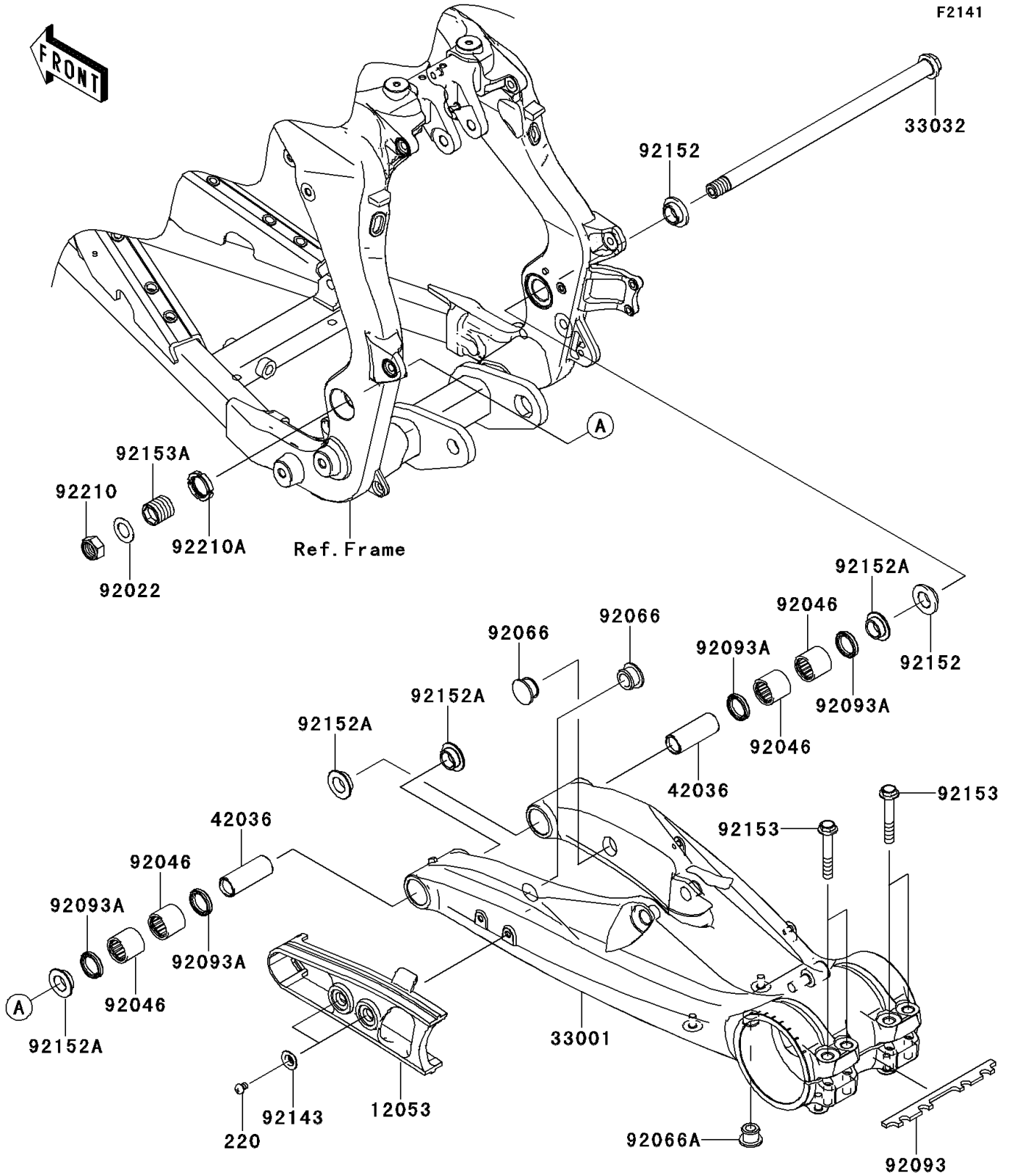

2009 KFX® 450R PARTS LIST

Swingarm

ITEM NAME	PART NUMBER	QUANTITY
SCREW-PAN-CROS,6X8 (Ref # 220)	220AA0608	2
GUIDE-CHAIN (Ref # 12053)	12053-0100	1
ARM-COMP-SWING (Ref # 33001)	33001-0157	1
SHAFT-SWING ARM (Ref # 33032)	33032-0019	1
SLEEVE (Ref # 42036)	42036-0036	2
WASHER,THRUST,16.5X28X1 (Ref # 92022)	92022-170	1
BEARING-NEEDLE,BM222925 (Ref # 92046)	92046-0027	4
PLUG (Ref # 92066)	92066-0074	2
PLUG (Ref # 92066A)	92066-0077	1
SEAL (Ref # 92093)	92093-0062	1
SEAL,SDO22X29X5 (Ref # 92093A)	92093-1435	4
COLLAR (Ref # 92143)	92143-1156	2
COLLAR (Ref # 92152)	92152-0402	2
COLLAR (Ref # 92152A)	92152-0431	4
BOLT,FLANGED,10X60 (Ref # 92153)	92153-1486	4
BOLT,PIVOT,24MM (Ref # 92153A)	92153-1600	1
NUT,LOCK,16MM (Ref # 92210)	92210-0179	1
NUT,PIVOT,24MM (Ref # 92210A)	92210-0294	1