

2010 Vulcan® 900 Classic PARTS DIAGRAM

Clutch

E1350

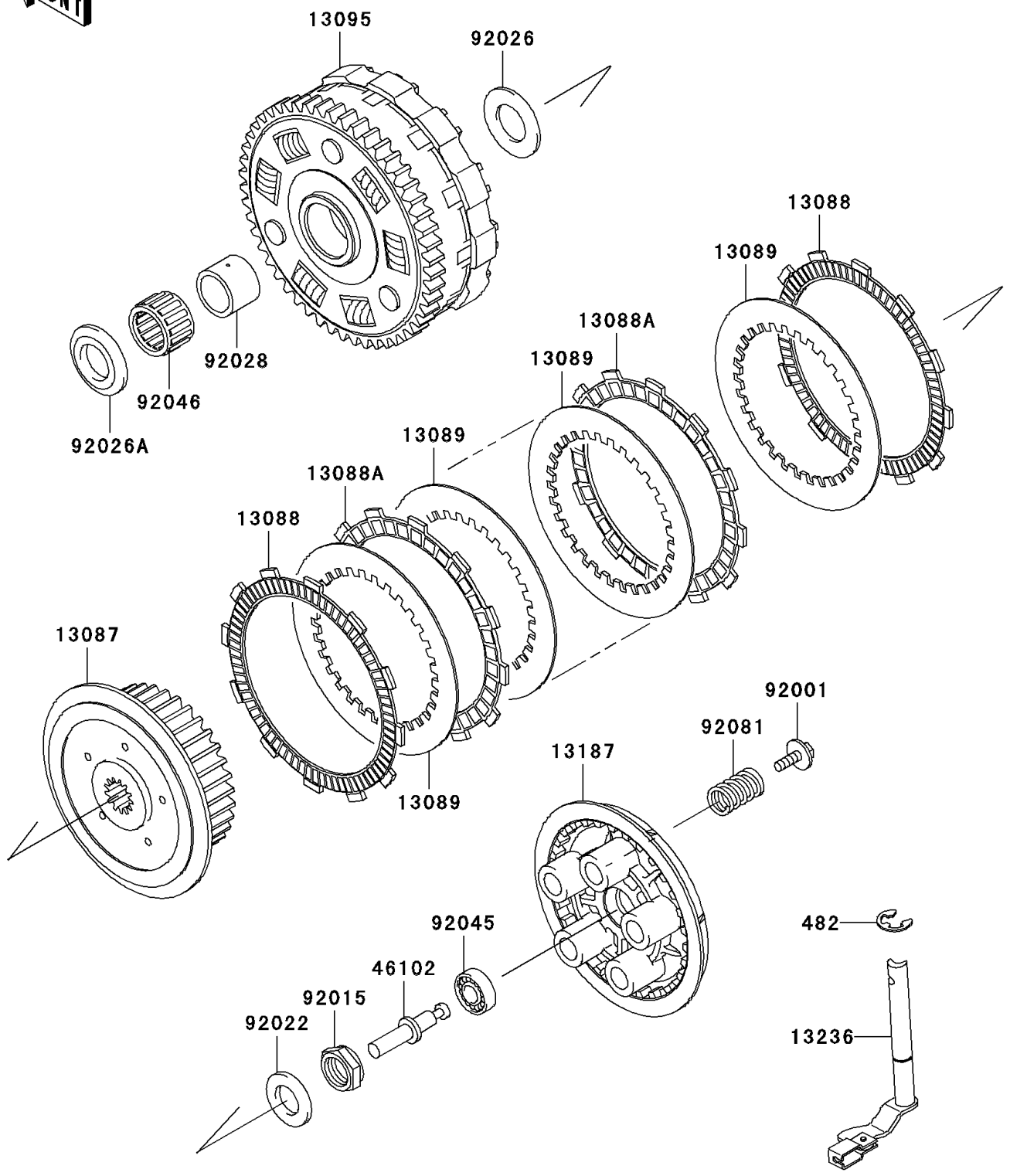

2010 Vulcan® 900 Classic PARTS LIST

Clutch

ITEM NAME	PART NUMBER	QUANTITY
CIRCLIP-TYPE-E,10MM (Ref # 482)	482J0100	1
HUB-CLUTCH (Ref # 13087)	13087-0042	1
PLATE-FRICTION (Ref # 13088)	13088-0023	2
PLATE-FRICTION (Ref # 13088A)	13088-1133	6
PLATE-CLUTCH (Ref # 13089)	13089-027	7
HOUSING-COMP-CLUTCH (Ref # 13095)	13095-0054	1
PLATE-CLUTCH OPERATING (Ref # 13187)	13187-1006	1
LEVER-COMP,CLUTCH RELEASE (Ref # 13236)	13236-1269	1
ROD,PULL (Ref # 46102)	46102-1374	1
BOLT,FLANGED,6X18 (Ref # 92001)	92001-1066	5
NUT,20MM (Ref # 92015)	92015-1555	1
WASHER,20.3X36X3.7 (Ref # 92022)	92022-1868	1
SPACER,25.5X47X2.5 (Ref # 92026)	92026-022	1
SPACER,THRUST,T=5.5 (Ref # 92026A)	92026-116	1
BUSHING,25X32X23.6 (Ref # 92028)	92028-178	1
BEARING-BALL,6001C3ML01 (Ref # 92045)	92045-1235	1
BEARING-NEEDLE,KTV323723 (Ref # 92046)	92046-028	1
SPRING,CLUTCH (Ref # 92081)	92081-1033	5