

2013 VULCAN® 900 CLASSIC PARTS DIAGRAM

Ignition Switch/Locks/Reflectors

F2770

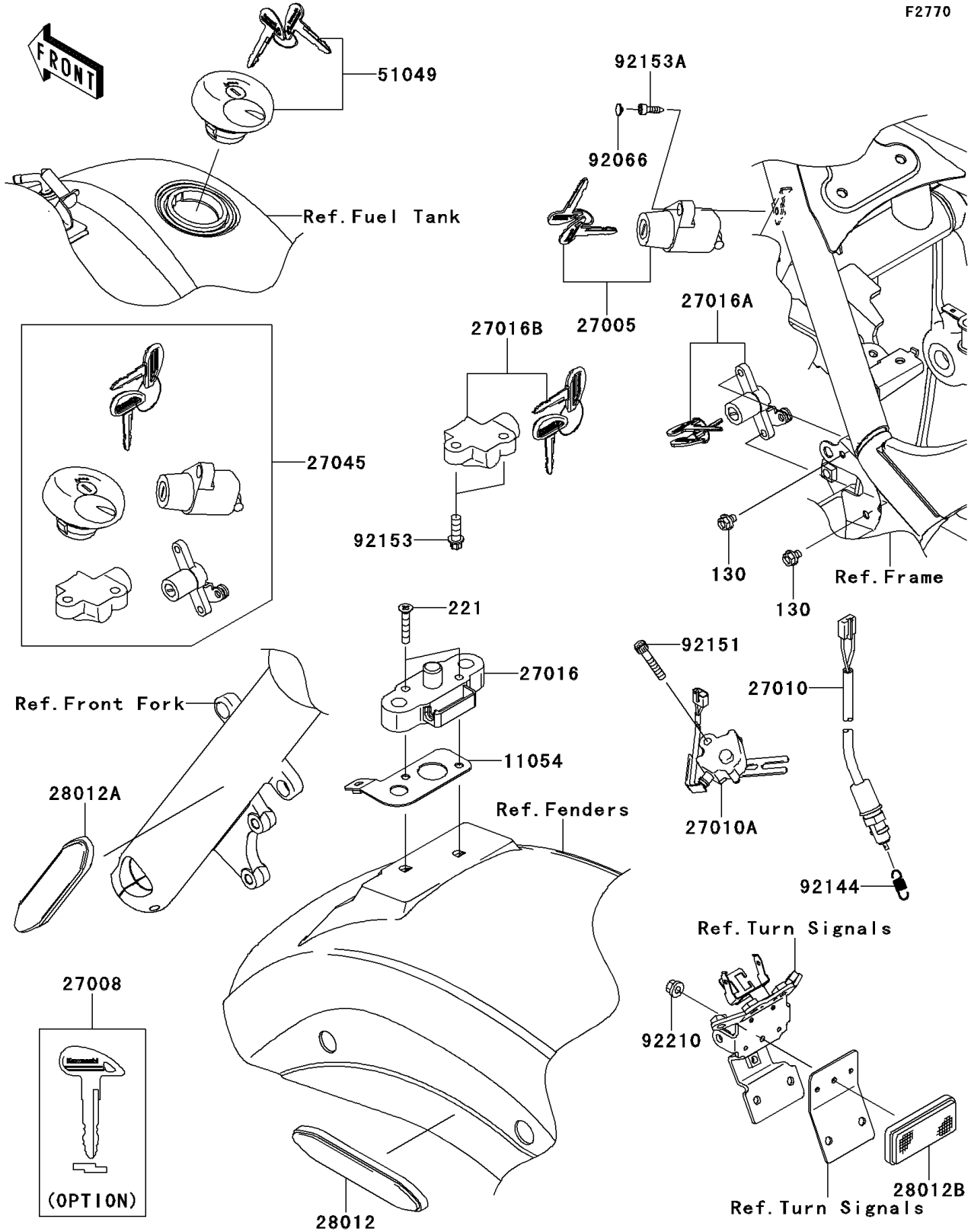

2013 VULCAN® 900 CLASSIC PARTS LIST

Ignition Switch/Locks/Reflectors

ITEM NAME	PART NUMBER	QUANTITY
BOLT-FLANGED,6X8 (Ref # 130)	130BB0608	2
SCREW-CSK-CROSS,6X35 (Ref # 221)	221AB0635	2
BRACKET,SEAT LOCK (Ref # 11054)	11054-0492	1
SWITCH-ASSY-IGNITION (Ref # 27005)	27005-0032	1
KEY-LOCK,BLANK (Ref # 27008)	27008-0042	1
SWITCH,REAR BRAKE (Ref # 27010)	27010-0050	1
SWITCH,SIDE STAND (Ref # 27010A)	27010-1470	1
LOCK-ASSY,SEAT STRIKER (Ref # 27016)	27016-1098	1
LOCK-ASSY,SEAT (Ref # 27016A)	27016-5341	1
LOCK-ASSY,STEERING (Ref # 27016B)	27016-5342	1
SWITCH-ASSY (Ref # 27045)	27045-5323	1
REFLECTOR-REFLEX (Ref # 28012)	28012-0010	2
REFLECTOR-REFLEX (Ref # 28012A)	28012-0019	2
REFLECTOR-REFLEX (Ref # 28012B)	28012-1077	1
CAP-TANK,FUEL (Ref # 51049)	51049-5001	1
PLUG (Ref # 92066)	92066-1543	1
SPRING,REAR BRAKE SWITCH (Ref # 92144)	92144-1141	1
BOLT,SOCKET,6X35 (Ref # 92151)	92151-1390	1
BOLT,TORX,8X22 (Ref # 92153)	92153-1273	2
BOLT,SOCKET,5X16 (Ref # 92153A)	92153-1685	1
NUT,FLANGED,5MM (Ref # 92210)	92210-0007	1