

2013 VULCAN® 900 CLASSIC LT PARTS DIAGRAM

Engine Mount

F2122

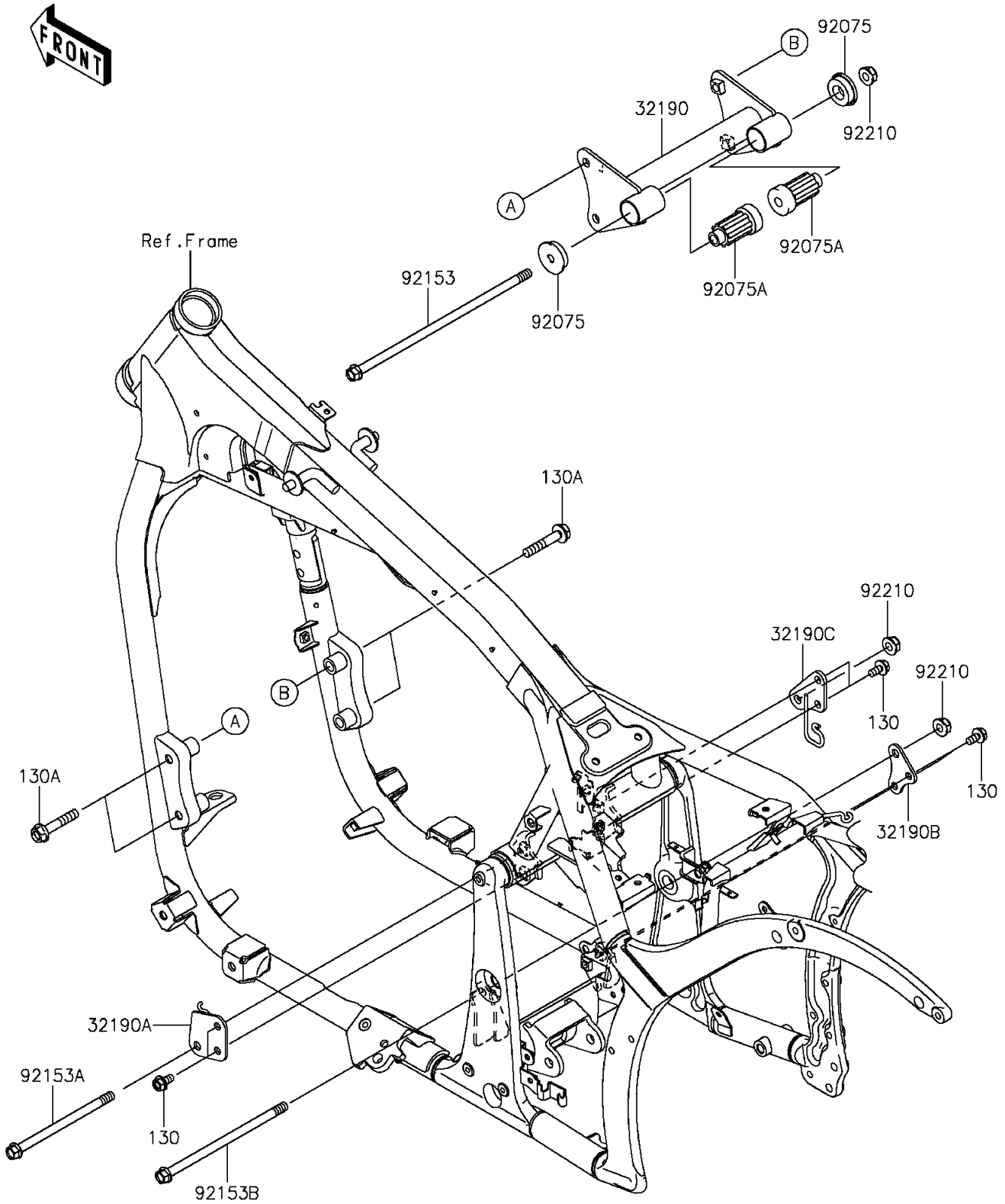

2013 VULCAN® 900 CLASSIC LT PARTS LIST

Engine Mount

ITEM NAME	PART NUMBER	QUANTITY
BOLT-FLANGED,8X16 (Ref # 130)	130BB0816	6
BOLT-FLANGED,10X55 (Ref # 130A)	130BB1055	4
BRACKET-ENGINE,FR,F.S.BLACK (Ref # 32190)	32190-0229-18R	1
BRACKET-ENGINE,RR,LH,UPP (Ref # 32190A)	32190-0274	1
BRACKET-ENGINE,RR,RH,LWR (Ref # 32190B)	32190-0275	1
BRACKET-ENGINE,RR,RH,UPP (Ref # 32190C)	32190-0276	1
DAMPER,ENGINE MOUNT (Ref # 92075)	92075-1738	2
DAMPER,ENGINE MOUNT,MAIN (Ref # 92075A)	92075-1739	2
BOLT,FLANGED,10X285 (Ref # 92153)	92153-1909	1
BOLT,FLANGED,10X158 (Ref # 92153A)	92153-1910	1
BOLT,FLANGED,10X198 (Ref # 92153B)	92153-1911	1
NUT,LOCK,FLANGED,10MM (Ref # 92210)	92210-1081	3