

2008 KX™100 PARTS DIAGRAM

Muffler(s)

E1140

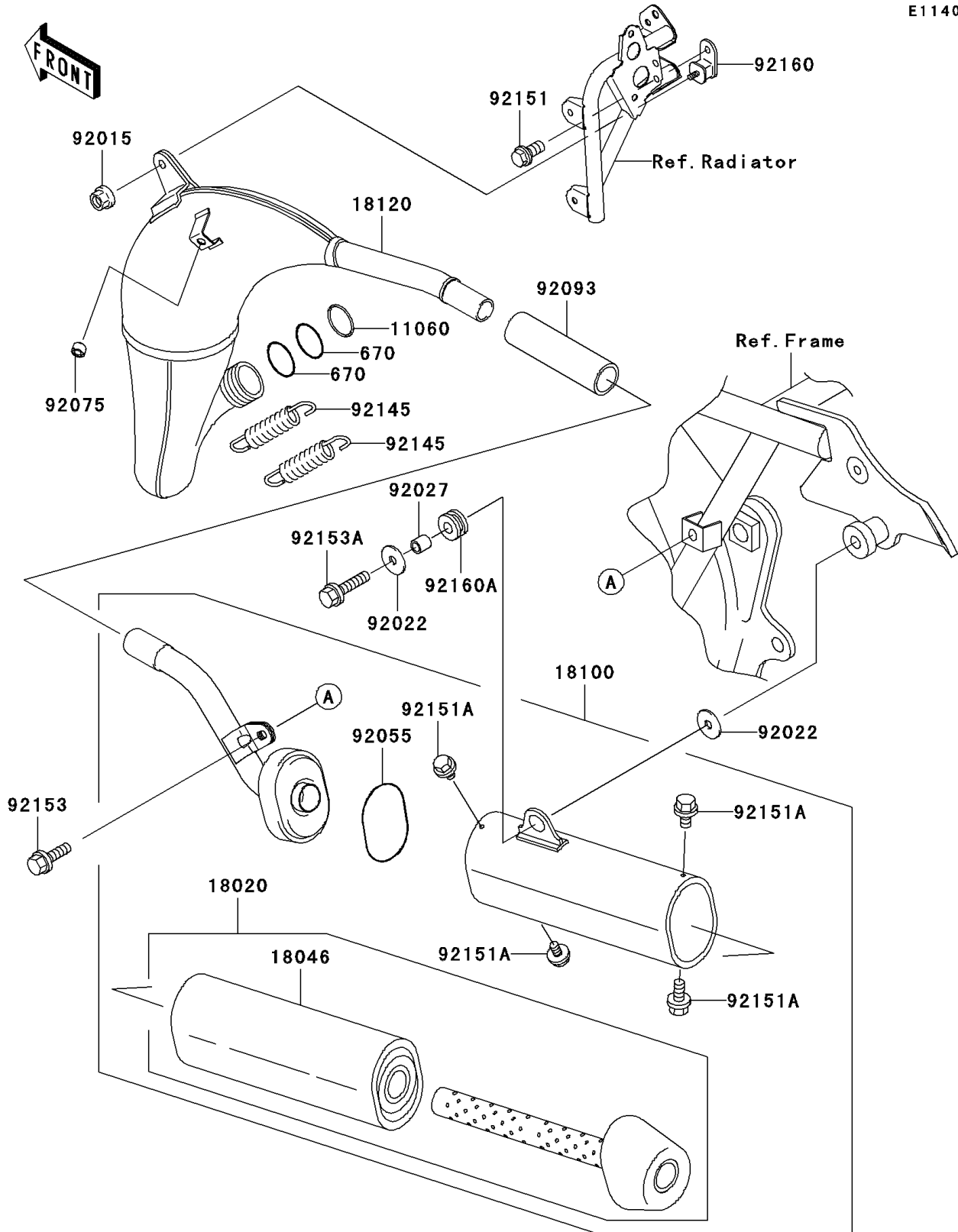

2008 KX™100 PARTS LIST

Muffler(s)

ITEM NAME	PART NUMBER	QUANTITY
O RING (Ref # 670)	670E3034	2
GASKET,EXHAUST HOLDER (Ref # 11060)	11060-1842	1
BAFFLE (Ref # 18020)	18020-1272	1
WOOL (Ref # 18046)	18046-1559	1
BODY-ASSY-MUFFLER (Ref # 18100)	18100-0016	1
CHAMBER-EXHAUST (Ref # 18120)	18120-1127	1
NUT,FLANGED,6MM (Ref # 92015)	92015-1078	1
WASHER,6.5X22X1.6 (Ref # 92022)	92022-237	2
COLLAR,6.8X10X10.5 (Ref # 92027)	92027-120	1
RING-O,BAFFLE PIPE (Ref # 92055)	92055-1461	1
DAMPER (Ref # 92075)	92075-1598	1
SEAL,MUFFLER JOINT (Ref # 92093)	92093-1200	1
SPRING,EXHAUST CONNECTING (Ref # 92145)	92145-1340	2
BOLT,6X12 (Ref # 92151)	92151-1133	1
BOLT,FLANGED,6X10 (Ref # 92151A)	92151-1822	4
BOLT,FLANGED WP,6X14 (Ref # 92153)	92153-1007	1
BOLT,FLANGED WP,6X25 (Ref # 92153A)	92153-1008	1
DAMPER,MUFFLER,FR (Ref # 92160)	92160-1176	1
DAMPER (Ref # 92160A)	92160-1913	1