

2012 VULCAN® 1700 CLASSIC PARTS DIAGRAM

Handlebar

F2310

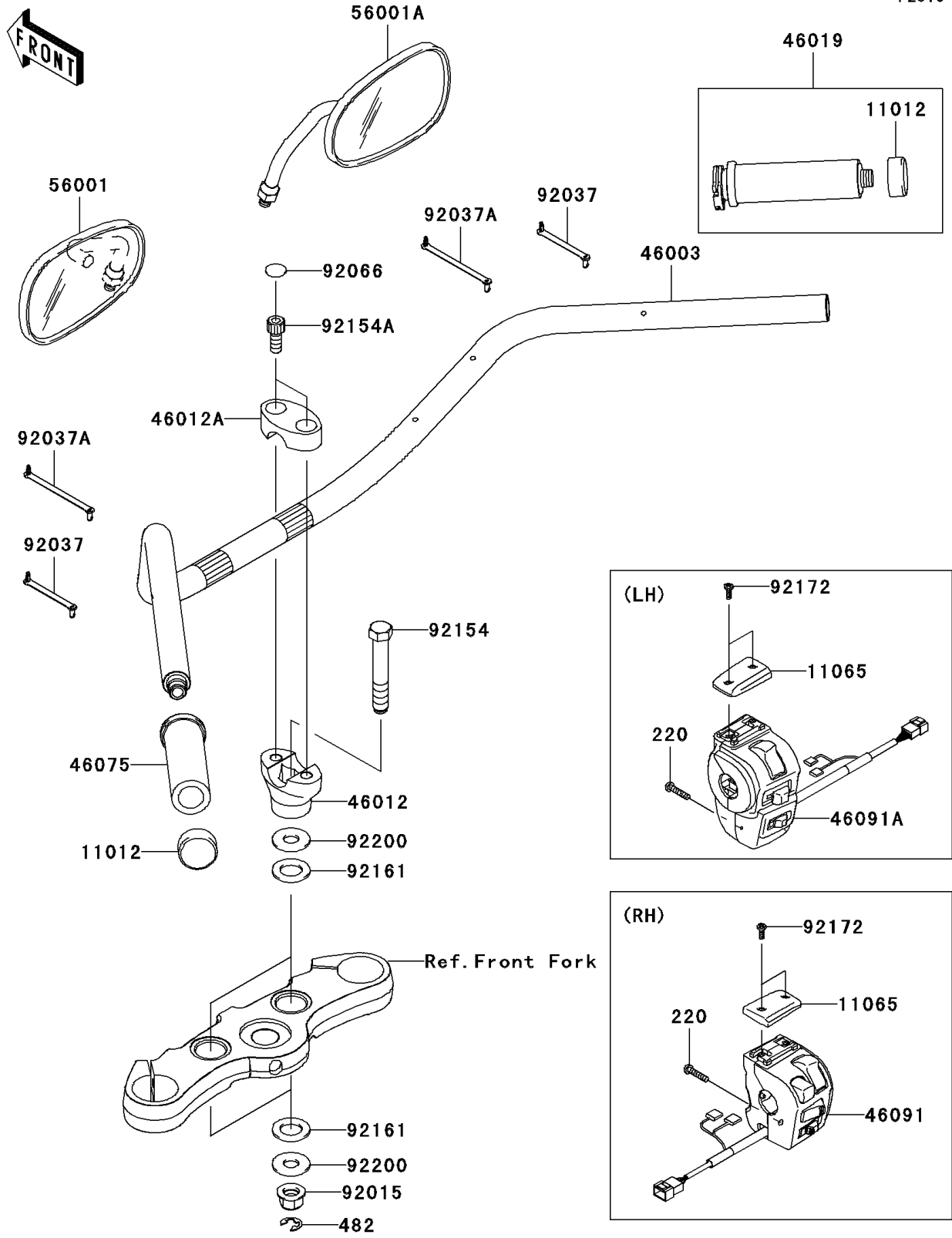

2012 VULCAN® 1700 CLASSIC PARTS LIST

Handlebar

ITEM NAME	PART NUMBER	QUANTITY
SCREW-PAN-CROSS,5X25 (Ref # 220)	220AB0525	2
CIRCLIP-TYPE-E,10MM (Ref # 482)	482EA0100	2
CAP,GRIP END (Ref # 11012)	11012-1975	2
CAP,HOUSING SWITCH (Ref # 11065)	11065-0310	2
HANDLE (Ref # 46003)	46003-0183	1
HOLDER-HANDLE,LWR (Ref # 46012)	46012-0078	2
HOLDER-HANDLE,UPP (Ref # 46012A)	46012-1273	2
GRIP-ASSY,THROTTLE (Ref # 46019)	46019-1109	1
GRIP,LH (Ref # 46075)	46075-1074	1
HOUSING-ASSY-CONTROL,RH (Ref # 46091)	46091-0167	1
HOUSING-ASSY-CONTROL,LH (Ref # 46091A)	46091-0170	1
MIRROR-ASSY,LH (Ref # 56001)	56001-0032	1
MIRROR-ASSY,RH (Ref # 56001A)	56001-0033	1
NUT,FLANGED,14MM (Ref # 92015)	92015-1401	2
CLAMP,SPEED,L=58 (Ref # 92037)	92037-1163	2
CLAMP,SPEED,L=80.5 (Ref # 92037A)	92037-1903	2
PLUG (Ref # 92066)	92066-1285	4
BOLT,UPSET,14X87 (Ref # 92154)	92154-0279	2
BOLT,SOCKET,10X25 (Ref # 92154A)	92154-0350	4
DAMPER,18X35X2.2 (Ref # 92161)	92161-0836	4
SCREW,4X12 (Ref # 92172)	92172-0421	4
WASHER,14.2X35X2.3 (Ref # 92200)	92200-0534	4