

2009 Vulcan® 1700 Classic PARTS DIAGRAM

Side Covers/Chain Cover

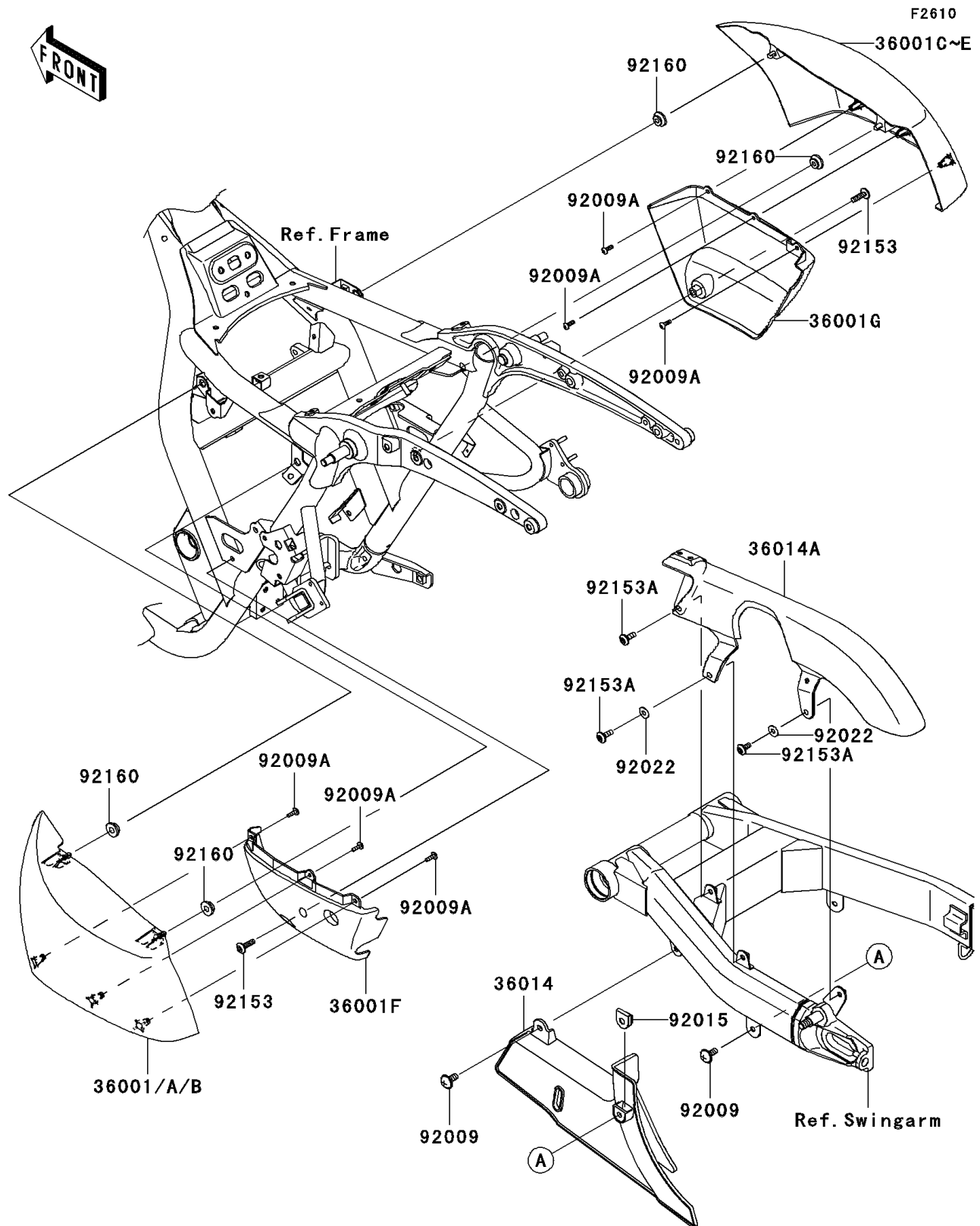

2009 Vulcan® 1700 Classic PARTS LIST

Side Covers/Chain Cover

ITEM NAME	PART NUMBER	QUANTITY
-----------	-------------	----------