

2014 NINJA® ZX™ -6R PARTS DIAGRAM

Crankcase

E1411

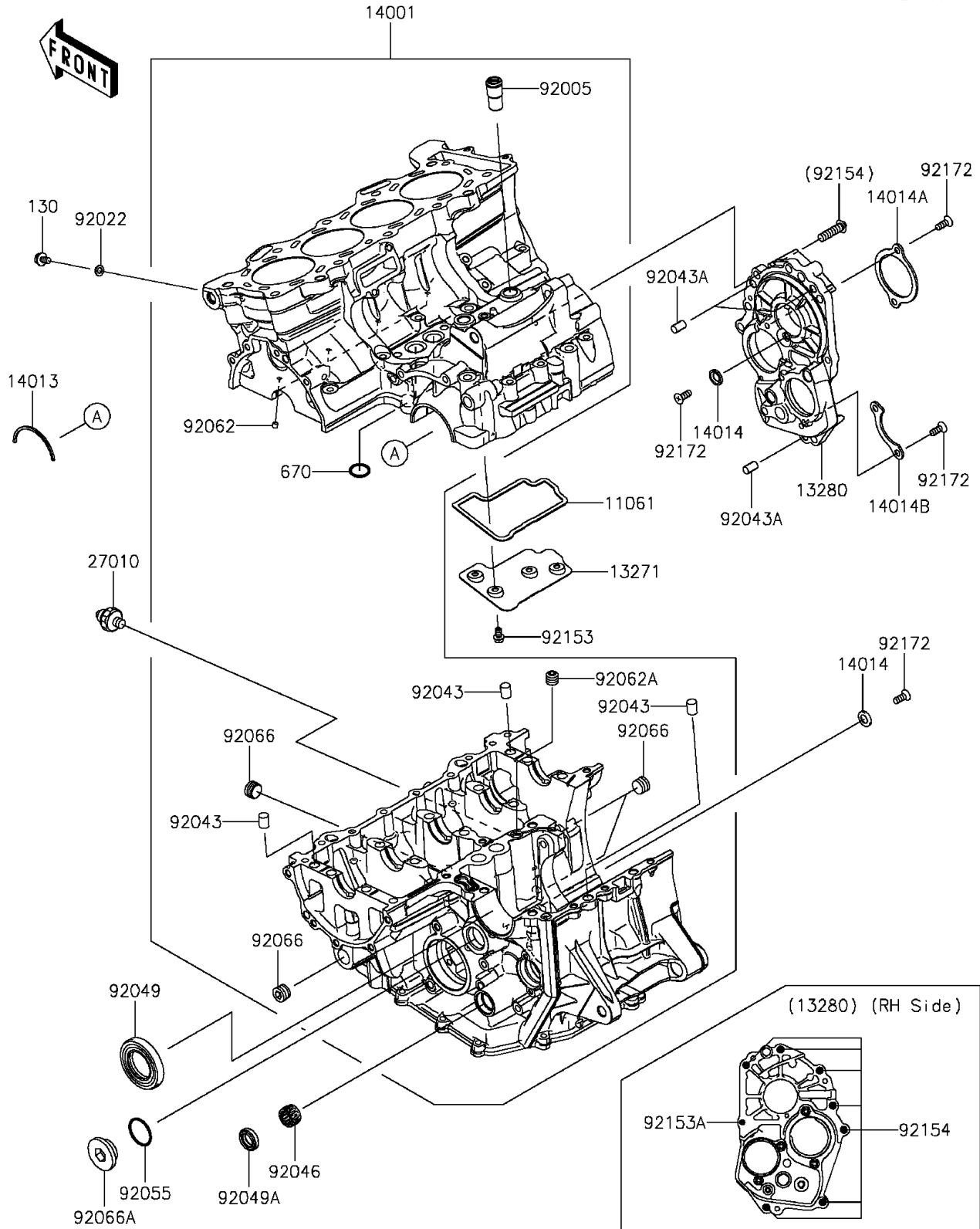

2014 NINJA® ZX™ -6R PARTS LIST

Crankcase

ITEM NAME	PART NUMBER	QUANTITY
BOLT-FLANGED,6X10 (Ref # 130)	130BD0610	1
O RING,18MM (Ref # 670)	670D2018	2
GASKET,BREATHER ROOM (Ref # 11061)	11061-0291	1
PLATE,BREATHER ROOM (Ref # 13271)	13271-0795	1
HOLDER,TRANSMISSION (Ref # 13280)	13280-0305	1
SET-CRANKCASE (Ref # 14001)	14001-0611	1
RING-POSITION (Ref # 14013)	14013-1051	1
PLATE-POSITION,9.5X17X2.3 (Ref # 14014)	14014-0019	2
PLATE-POSITION (Ref # 14014A)	14014-0029	1
PLATE-POSITION (Ref # 14014B)	14014-0030	1
SWITCH,OIL PRESSURE (Ref # 27010)	27010-1313	1
FITTING,BREATHER (Ref # 92005)	92005-1238	1
WASHER,6.2X11X1 (Ref # 92022)	92022-304	1
PIN,10X14 (Ref # 92043)	92043-1506	3
PIN,8X14 (Ref # 92043A)	92043-1567	3
BEARING-NEEDLE,HK1412FM (Ref # 92046)	92046-0043	1
SEAL-OIL,TC32578 (Ref # 92049)	92049-1474	1
SEAL-OIL,TC14245 (Ref # 92049A)	92049-1520	1
RING-O,27.7X2.4 (Ref # 92055)	92055-091	1
NOZZLE (Ref # 92062)	92062-0019	4
NOZZLE (Ref # 92062A)	92062-1056	1
PLUG,PT3/8X10 (Ref # 92066)	92066-0003	4
PLUG,25X8 (Ref # 92066A)	92066-1161	1
BOLT,6X10 (Ref # 92153)	92153-0381	4
BOLT,TORX,6X25 (Ref # 92153A)	92153-1640	1
BOLT,TORX,8X28 (Ref # 92154)	92154-0415	7
SCREW,6X16 (Ref # 92172)	92172-0090	6