

2014 NINJA® ZX™ -6R ABS PARTS DIAGRAM

Handlebar

F2310

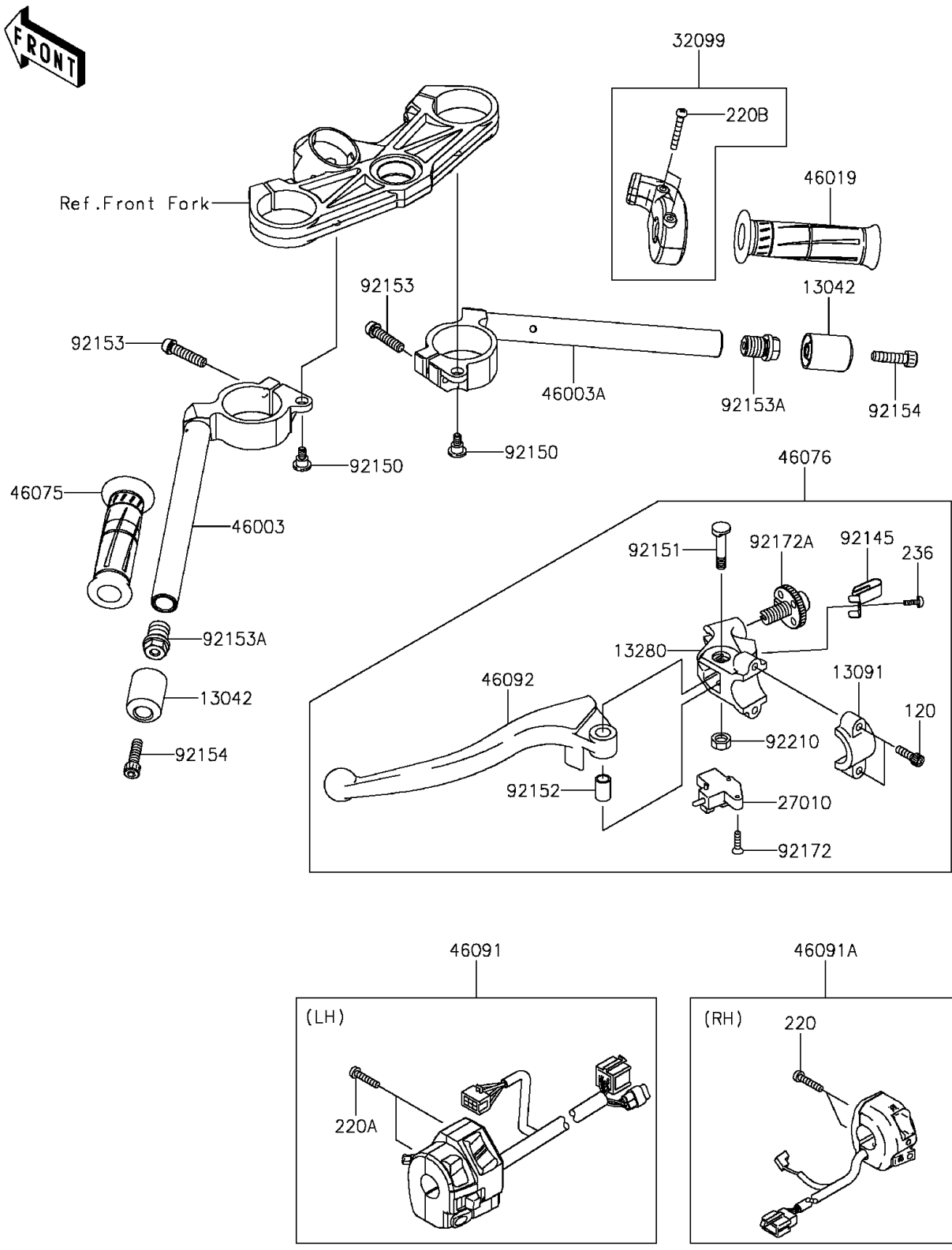

2014 NINJA® ZX™ -6R ABS PARTS LIST

Handlebar

ITEM NAME	PART NUMBER	QUANTITY
BOLT-SOCKET,6X20 (Ref # 120)	120CA0620	2
SCREW-PAN-CROS,5X22 (Ref # 220)	220AB0522	2
SCREW-PAN-CROS,5X25 (Ref # 220A)	220AB0525	2
SCREW-PAN-CROS,5X35 (Ref # 220B)	220AB0535	2
SCREW-PAN-WSP-CROS,4X10 (Ref # 236)	236AB0410	1
WEIGHT,HANDLE (Ref # 13042)	13042-5001	2
HOLDER,CLUTCH LEVER (Ref # 13091)	13091-1624	1
HOLDER,CLUTCH LEVER (Ref # 13280)	13280-1160	1
SWITCH,CLUTCH (Ref # 27010)	27010-0717	1
CASE,THROTTLE (Ref # 32099)	32099-0049	1
HANDLE,LH (Ref # 46003)	46003-0600	1
HANDLE,RH (Ref # 46003A)	46003-0601	1
GRIP-ASSY,THROTTLE (Ref # 46019)	46019-0020	1
GRIP,LH (Ref # 46075)	46075-0068	1
LEVER-ASSY-GRIP,CLUTCH (Ref # 46076)	46076-0078	1
HOUSING-ASSY-CONTROL,LH (Ref # 46091)	46091-0258	1
HOUSING-ASSY-CONTROL,RH (Ref # 46091A)	46091-0261	1
LEVER-GRIP,CLUTCH (Ref # 46092)	46092-0006	1
SPRING (Ref # 92145)	92145-1286	1
BOLT,6MM (Ref # 92150)	92150-1090	2
BOLT (Ref # 92151)	92151-1523	1
COLLAR (Ref # 92152)	92152-0103	1
BOLT,SOCKET,8X35 (Ref # 92153)	92153-0907	2
BOLT,17X18 (Ref # 92153A)	92153-1667	2
BOLT,SOCKET,8X30 (Ref # 92154)	92154-0502	2
SCREW,3X16 (Ref # 92172)	92172-0183	2
SCREW,ADJUST NUT (Ref # 92172A)	92172-1060	1
NUT,LOCK,6MM (Ref # 92210)	92210-0006	1