

Mule 2510 4X4 PARTS DIAGRAM

Cylinder Head

E1111

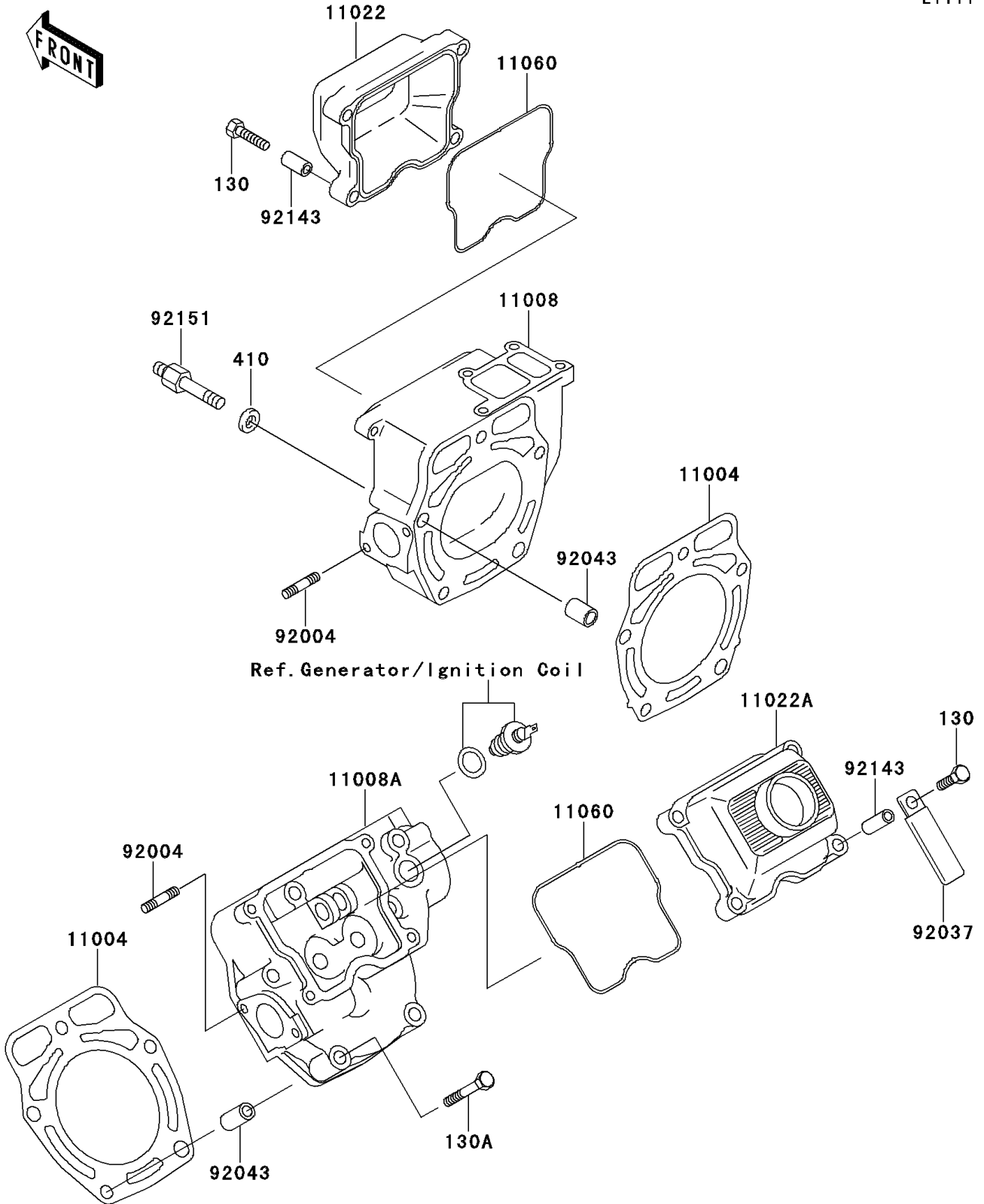

Mule 2510 4X4 PARTS LIST

Cylinder Head

ITEM NAME	PART NUMBER	QUANTITY
BOLT-FLANGED,6X25 (Ref # 130)	130B0625	8
BOLT-FLANGED,8X65 (Ref # 130A)	130G0865	9
WASHER-PLAIN-SMALL,8MM (Ref # 410)	410B0800	1
GASKET-HEAD (Ref # 11004)	11004-2107	2
HEAD-COMP-CYLINDER (Ref # 11008)	11008-2135	1
HEAD-COMP-CYLINDER (Ref # 11008A)	11008-6036	1
CASE-ROCKER (Ref # 11022)	11022-2056	1
CASE-ROCKER (Ref # 11022A)	11022-2068	1
GASKET,ROCKER CASE (Ref # 11060)	11060-2332	2
STUD (Ref # 92004)	92004-2142	4
CLAMP,WIRING HARNESS,L=60 (Ref # 92037)	92037-1069	1
PIN,DOWEL,10X14 (Ref # 92043)	92043-1037	4
COLLAR (Ref # 92143)	92143-2010	8
BOLT (Ref # 92151)	92151-2070	1