

Mule 2500 PARTS DIAGRAM

Chassis Electrical Equipment

F2760

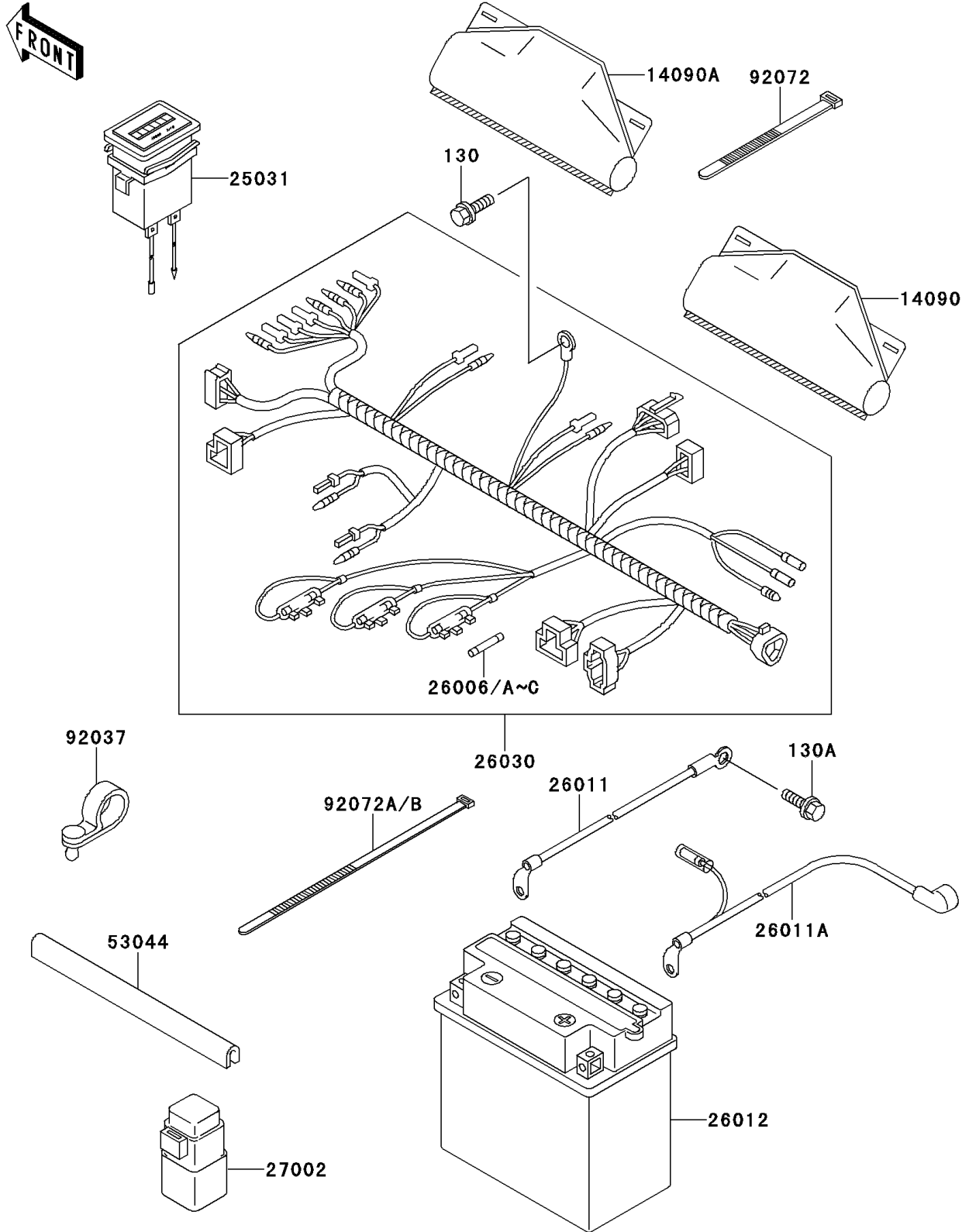

Mule 2500 PARTS LIST

Chassis Electrical Equipment

ITEM NAME	PART NUMBER	QUANTITY
BOLT-FLANGED (Ref # 130)	130J0612	1
BOLT-FLANGED (Ref # 130A)	130J0812	1
COVER,COUPLER (Ref # 14090)	14090-1331	2
COVER,COUPLER (Ref # 14090A)	14090-1611	1
METER-ASSY,HOUR (Ref # 25031)	25031-1013	1
FUSE,8A,L=30 (Ref # 26006)	26006-1062	1
FUSE,5A,L=32 (Ref # 26006A)	26006-1063	1
FUSE,20A,L=32 (Ref # 26006B)	26006-1064	2
FUSE,30A,L=32 (Ref # 26006C)	26006-1065	1
WIRE-LEAD,BATTERY(-) (Ref # 26011)	26011-1444	1
WIRE-LEAD,BATTERY(+) (Ref # 26011A)	26011-1551	1
BATTERY,YB16CL-B,12V 19AH (Ref # 26012)	26012-1242	1
HARNESS,MAIN (Ref # 26030)	26030-1617	1
RELAY-ASSY (Ref # 27002)	27002-1068	1
TRIM (Ref # 53044)	53044-1137	1
CLAMP,HOSE (Ref # 92037)	92037-1827	2
BAND,L=123 (Ref # 92072)	92072-030	6
BAND,L=365 (Ref # 92072A)	92072-1197	6
BAND,L=188 (Ref # 92072B)	92072-1239	6