

# 2014 Brute Force® 750 4x4i EPS PARTS DIAGRAM

Handlebar

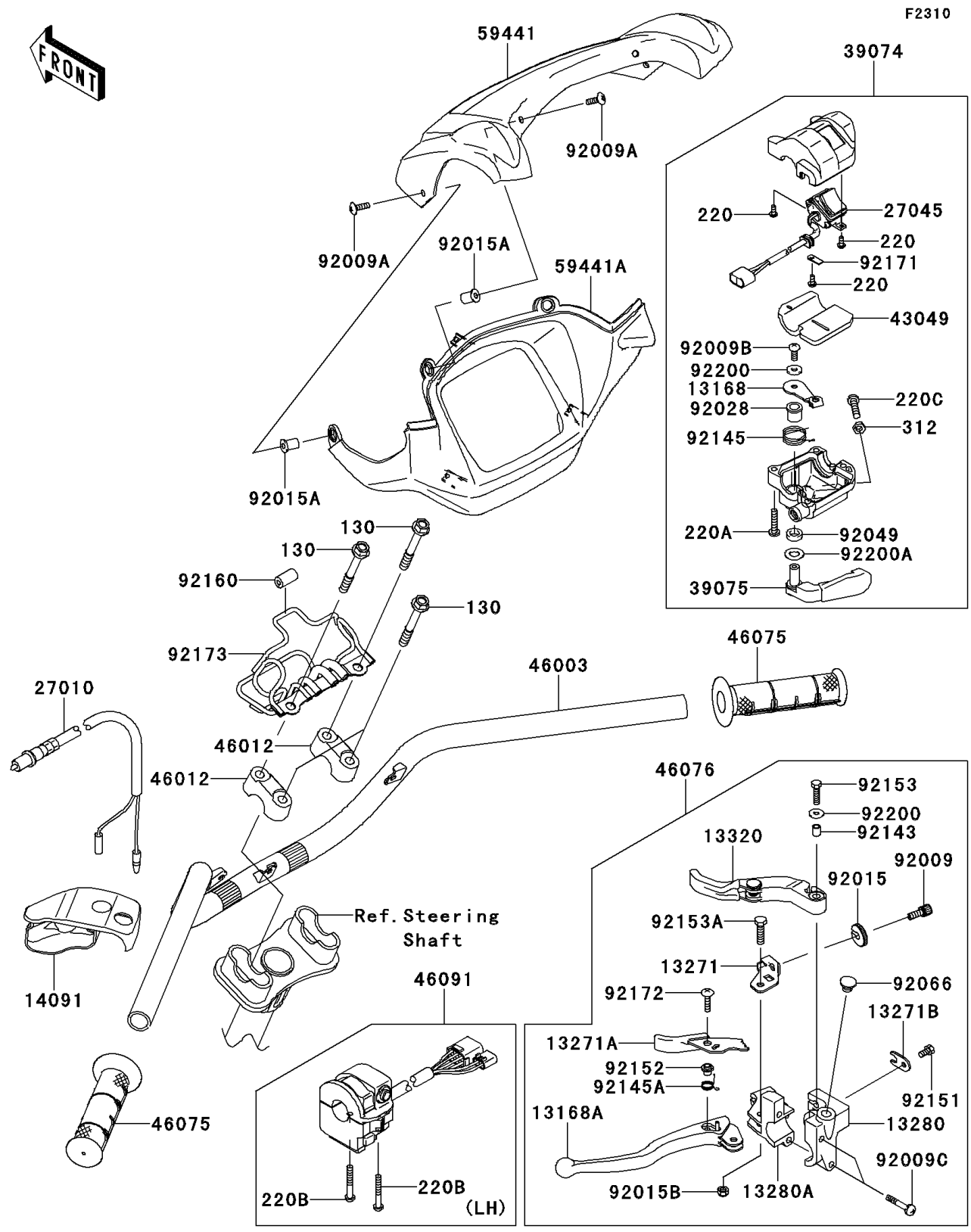

# 2014 Brute Force® 750 4x4i EPS PARTS LIST

Handlebar

ITEM NAME	PART NUMBER	QUANTITY
-----------	-------------	----------