

2014 CONCOURS® 14 ABS PARTS DIAGRAM

Generator

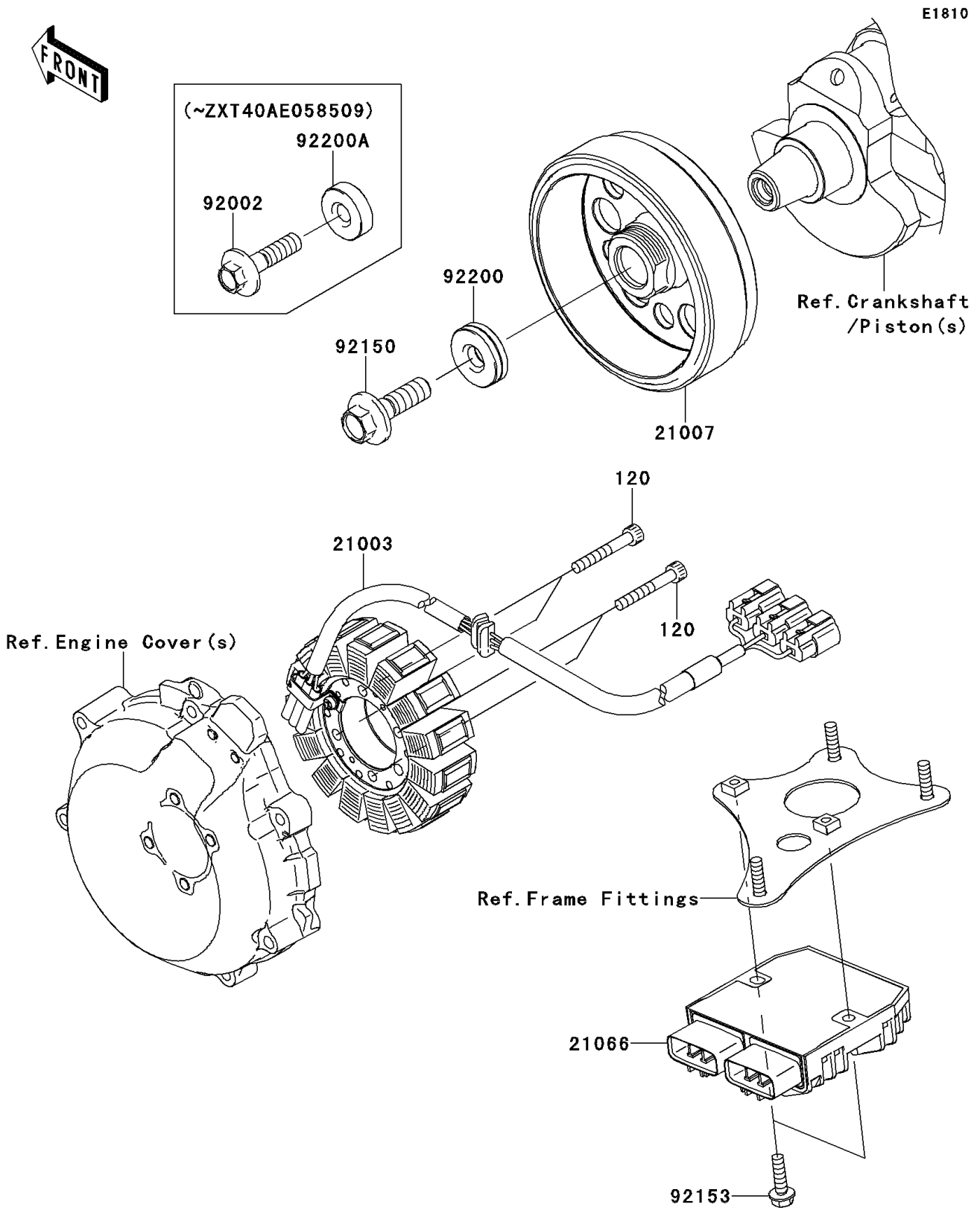

2014 CONCOURS® 14 ABS PARTS LIST

Generator

ITEM NAME	PART NUMBER	QUANTITY
-----------	-------------	----------