

2014 CONCOURS® 14 ABS PARTS DIAGRAM

Rear Fender(s)

F2172

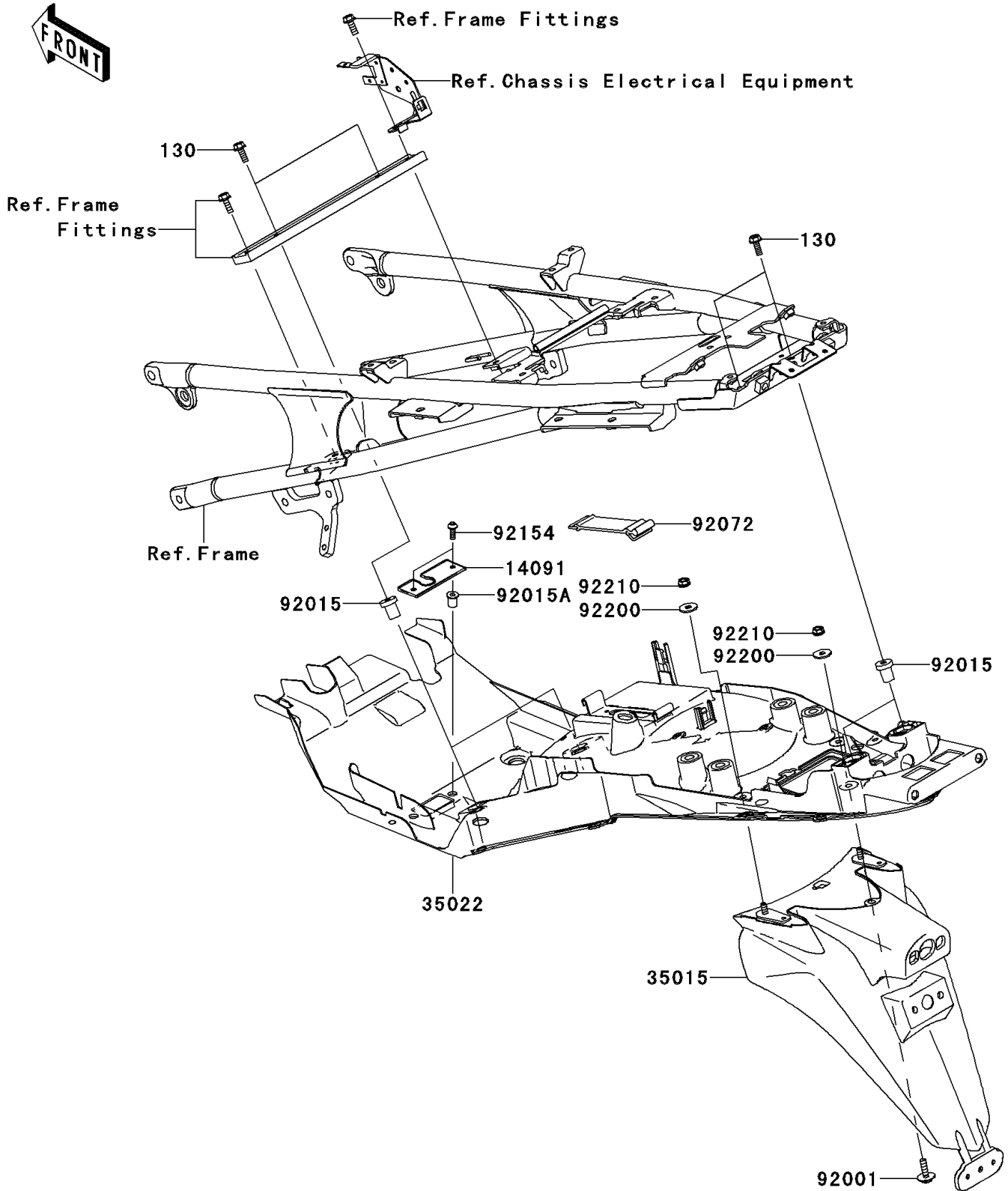

2014 CONCOURS® 14 ABS PARTS LIST

Rear Fender(s)

ITEM NAME	PART NUMBER	QUANTITY
-----------	-------------	----------