

2011 PRAIRIE® 360 4x4 PARTS DIAGRAM

Camshaft(s)/Tensioner

E1230

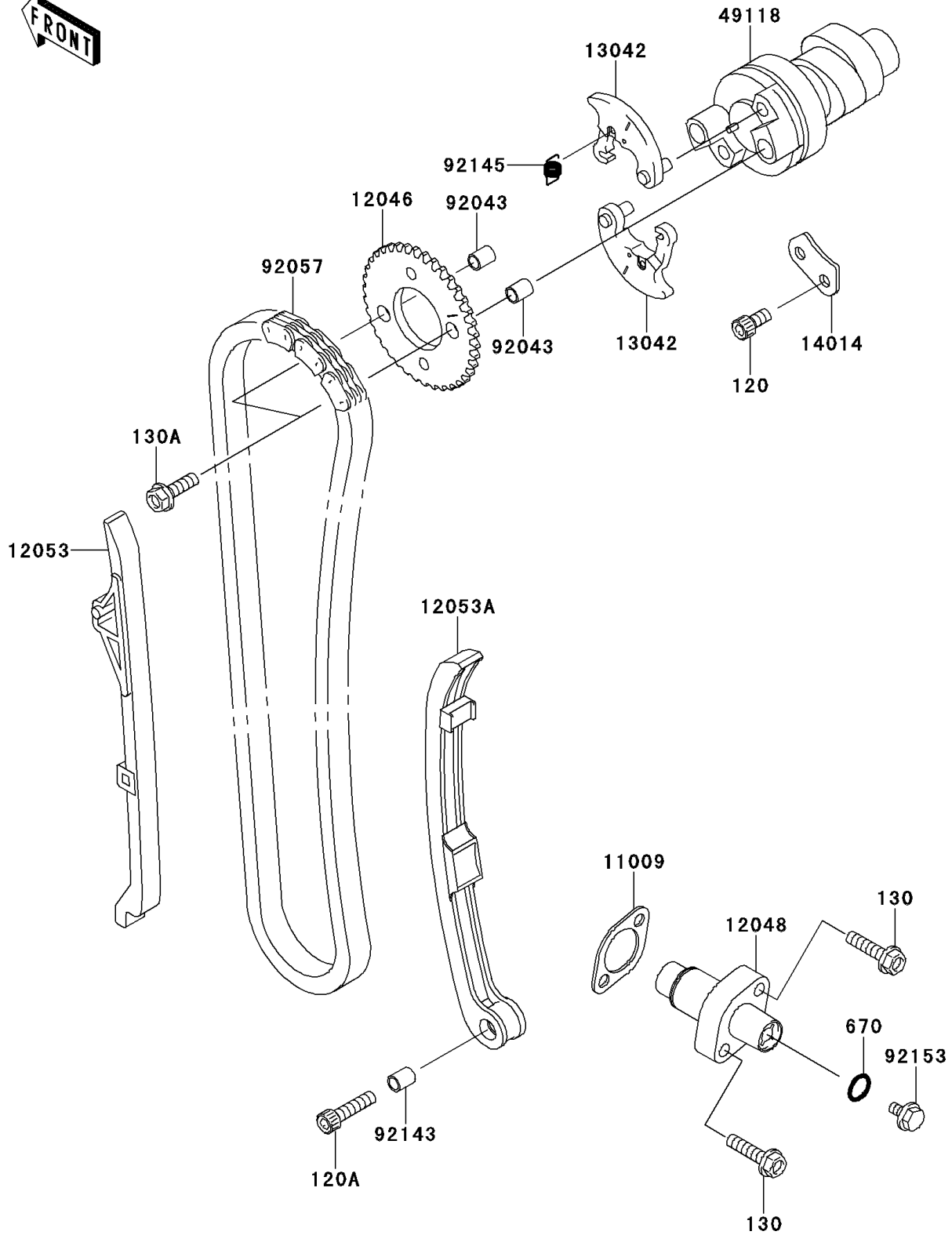

2011 PRAIRIE® 360 4x4 PARTS LIST

Camshaft(s)/Tensioner

ITEM NAME	PART NUMBER	QUANTITY
BOLT-SOCKET,6X12 (Ref # 120)	120CA0612	2
BOLT-SOCKET,6X25 (Ref # 120A)	120CA0625	1
BOLT-FLANGED,6X25 (Ref # 130)	130BB0625	2
BOLT-FLANGED,6X20 (Ref # 130A)	130CD0620	2
O RING (Ref # 670)	670D2010	1
GASKET,TENSIONER (Ref # 11009)	11009-1858	1
SPROCKET,38T (Ref # 12046)	12046-1225	1
TENSIONER-ASSY (Ref # 12048)	12048-1193	1
GUIDE-CHAIN,FR (Ref # 12053)	12053-1423	1
GUIDE-CHAIN,TENSIONER (Ref # 12053A)	12053-1451	1
WEIGHT,DECOMP (Ref # 13042)	13042-1149	2
PLATE-POSITION (Ref # 14014)	14014-1095	1
CAMSHAFT-COMP (Ref # 49118)	49118-1217	1
PIN,DOWEL,8X10 (Ref # 92043)	92043-1302	2
CHAIN,CAM,82RH2010-118L (Ref # 92057)	92057-1256	1
COLLAR,6X8X10.2 (Ref # 92143)	92143-1253	1
SPRING,DECOMP (Ref # 92145)	92145-1495	1
BOLT,6X6 (Ref # 92153)	92153-1380	1