

2013 PRAIRIE® 360 4x4 PARTS DIAGRAM

Chassis Electrical Equipment

F2760

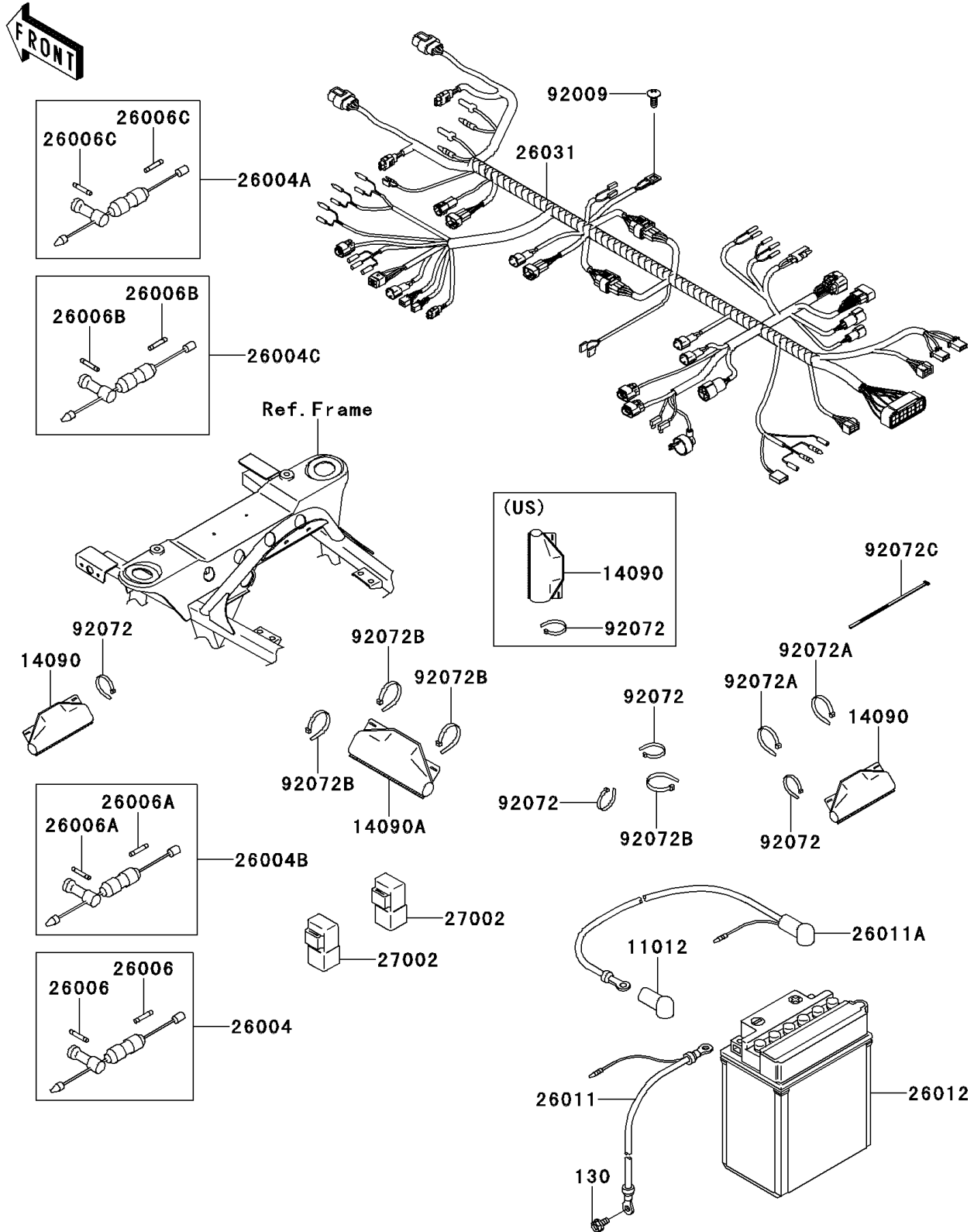

2013 PRAIRIE® 360 4x4 PARTS LIST

Chassis Electrical Equipment

ITEM NAME	PART NUMBER	QUANTITY
BOLT-FLANGED,6X12 (Ref # 130)	130AA0612	1
CAP,TERMINAL (Ref # 11012)	11012-1354	1
COVER,COUPLER (Ref # 14090A)	14090-1611	1
FUSE-ASSY (Ref # 26004)	26004-0005	1
FUSE-ASSY (Ref # 26004A)	26004-1114	1
FUSE-ASSY (Ref # 26004B)	26004-1127	1
FUSE-ASSY (Ref # 26004C)	26004-7501	1
FUSE,GLASS TUBE,6.4X30,10A,YEL (Ref # 26006)	26006-0003	2
FUSE,GLASS TUBE,6.4X30,30A (Ref # 26006A)	26006-1059	2
FUSE,GLASS TUBE,6.4X31.8,20A (Ref # 26006B)	26006-1064	2
FUSE,GLASS TUBE,6.4X30,5A,BRN (Ref # 26006C)	26006-1074	2
WIRE-LEAD,BATTERY(-) (Ref # 26011)	26011-0139	1
WIRE-LEAD,BATTERY(+) (Ref # 26011A)	26011-0140	1
BATTERY,YB14A-A2,12V 14AH (Ref # 26012)	26012-0142	1
HARNESS,MAIN (Ref # 26031)	26031-0526	1
RELAY-ASSY (Ref # 27002)	27002-1088	2
SCREW,TAPPING,6X16 (Ref # 92009)	92009-1166	1
BAND,L=149 (Ref # 92072A)	92072-031	2
BAND,L=186 (Ref # 92072B)	92072-056	4
BAND,L=188 (Ref # 92072C)	92072-1239	21
COVER,COUPLER (Ref # 14090)	14090-1331	2
COVER,COUPLER (Ref # 14090)	14090-1331	3
BAND,L=123 (Ref # 92072)	92072-030	4
BAND,L=123 (Ref # 92072)	92072-030	5