

2011 KX™ 65 PARTS DIAGRAM

Rear Suspension

F2150

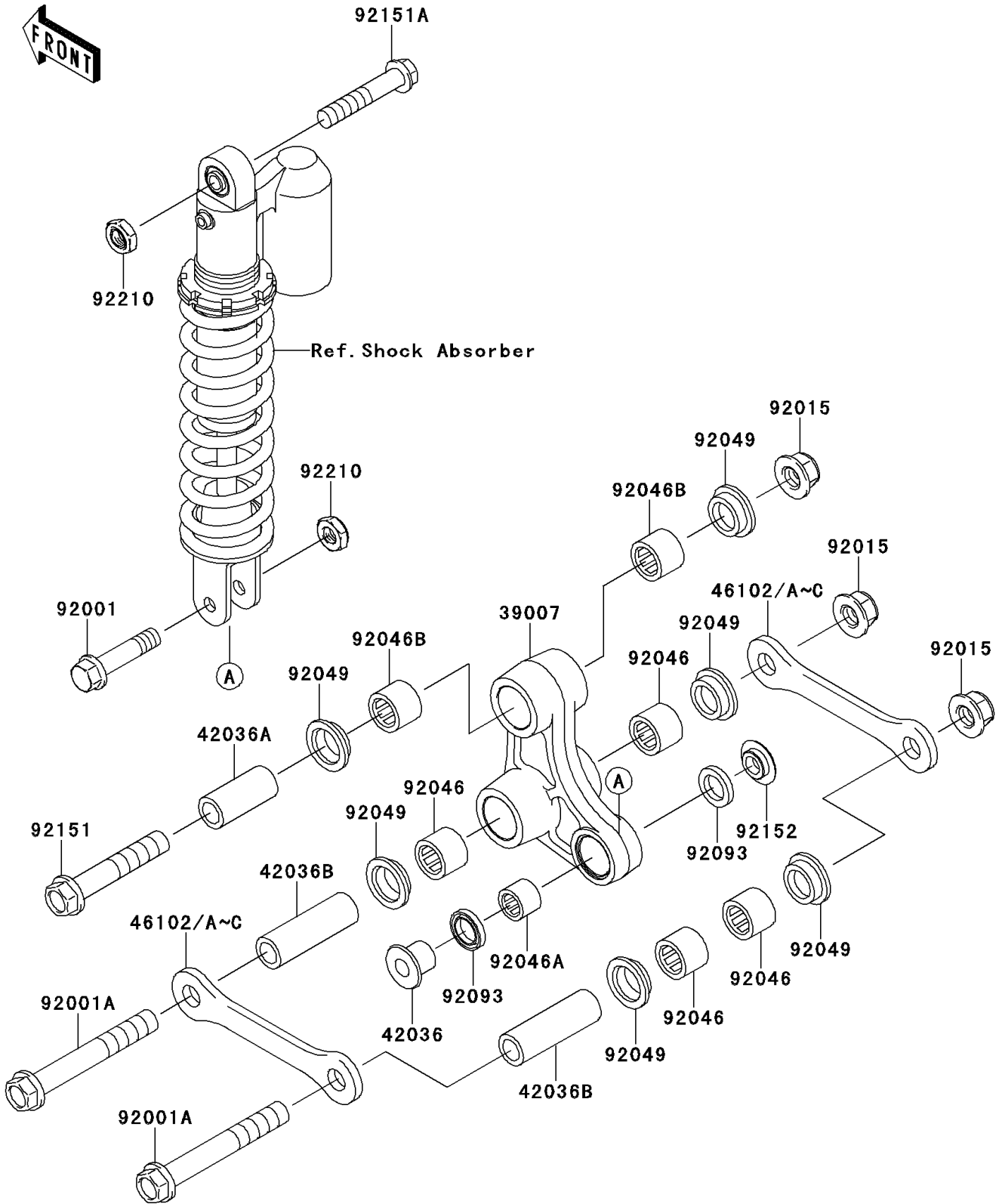

2011 KX™ 65 PARTS LIST

Rear Suspension

ITEM NAME	PART NUMBER	QUANTITY
ARM-SUSP,UNI TRAK (Ref # 39007)	39007-1299	1
SLEEVE (Ref # 42036)	42036-1351	1
SLEEVE,12X18X40 (Ref # 42036A)	42036-1364	1
SLEEVE,12X18X61 (Ref # 42036B)	42036-1370	2
ROD,SUSPENSION,L=88.3 (Ref # 46102)	46102-1430	2
ROD,SUSPENSION,L=87.3 (Ref # 46102A)	46102-1431	2
ROD,SUSPENSION,L=86.3 (Ref # 46102B)	46102-1432	2
ROD,SUSPENSION,L=85.3 (Ref # 46102C)	46102-1433	2
BOLT,FLANGED,10X44 (Ref # 92001)	92001-1499	1
BOLT,FLANGED,12X88 (Ref # 92001A)	92001-1693	2
NUT,LOCK,FLANGED,12MM (Ref # 92015)	92015-1433	3
BEARING-NEEDLE,18BM2416 (Ref # 92046)	92046-1144	4
BEARING-NEEDLE,16BM2212 (Ref # 92046A)	92046-1192	1
BEARING-NEEDLE,HK1812 (Ref # 92046B)	92046-1271	2
SEAL-OIL (Ref # 92049)	92049-1328	6
SEAL (Ref # 92093)	92093-1436	2
BOLT,FLANGED,12X67 (Ref # 92151)	92151-1766	1
BOLT,FLANGED,10X54 (Ref # 92151A)	92151-1785	1
COLLAR (Ref # 92152)	92152-1139	1
NUT,LOCK,10MM (Ref # 92210)	92210-1184	2