

2008 KLX®110 PARTS DIAGRAM

Rear Suspension

F2150

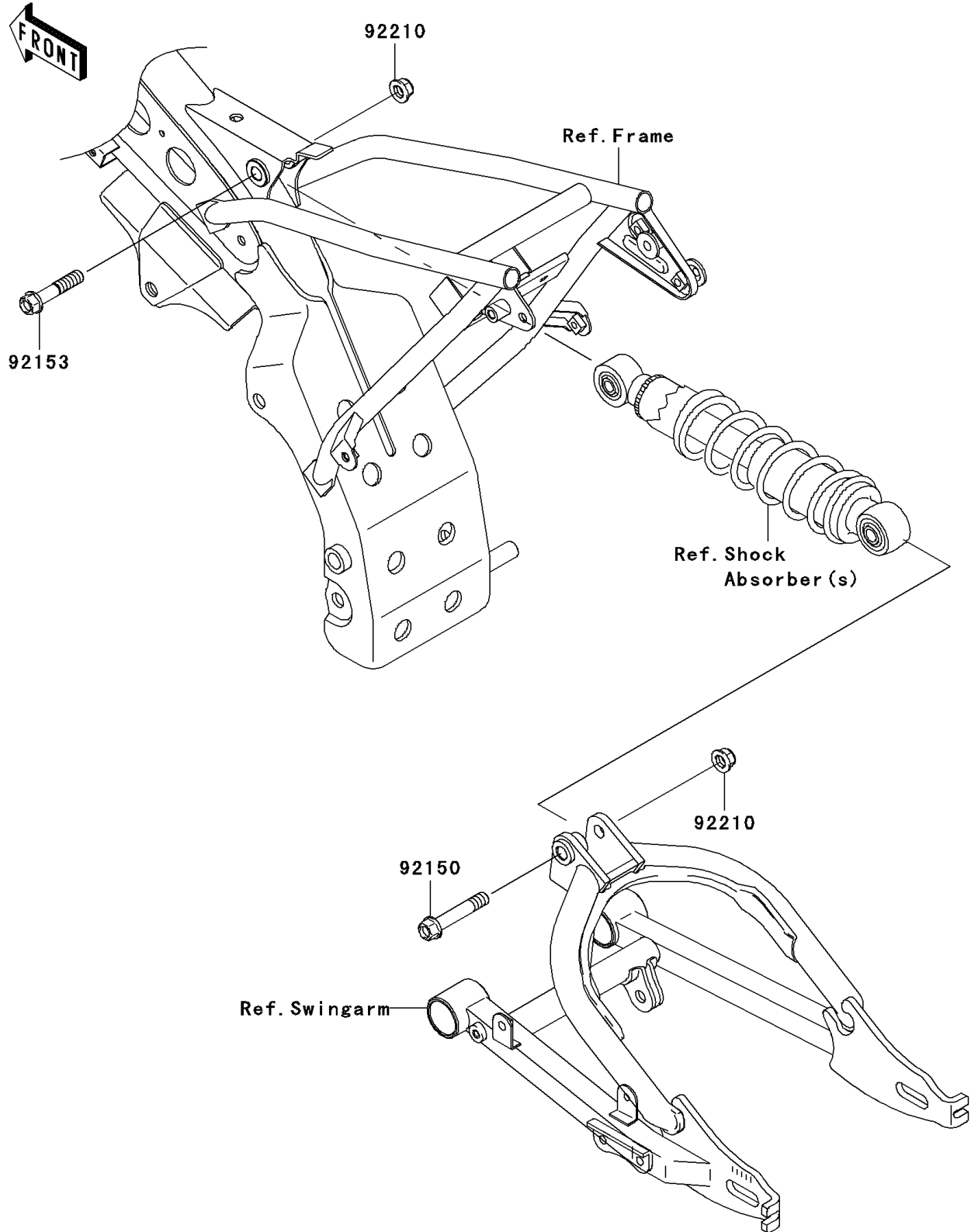

2008 KLX®110 PARTS LIST

Rear Suspension

ITEM NAME	PART NUMBER	QUANTITY
BOLT,FLANGED,10X57 (Ref # 92150)	92150-1227	1
BOLT,FLANGED,10X50 (Ref # 92153)	92153-1139	1
NUT,LOCK,FLANGED,10MM (Ref # 92210)	92210-1080	2