

# 2008 KLX®110 PARTS DIAGRAM

Guard(s)

F2680

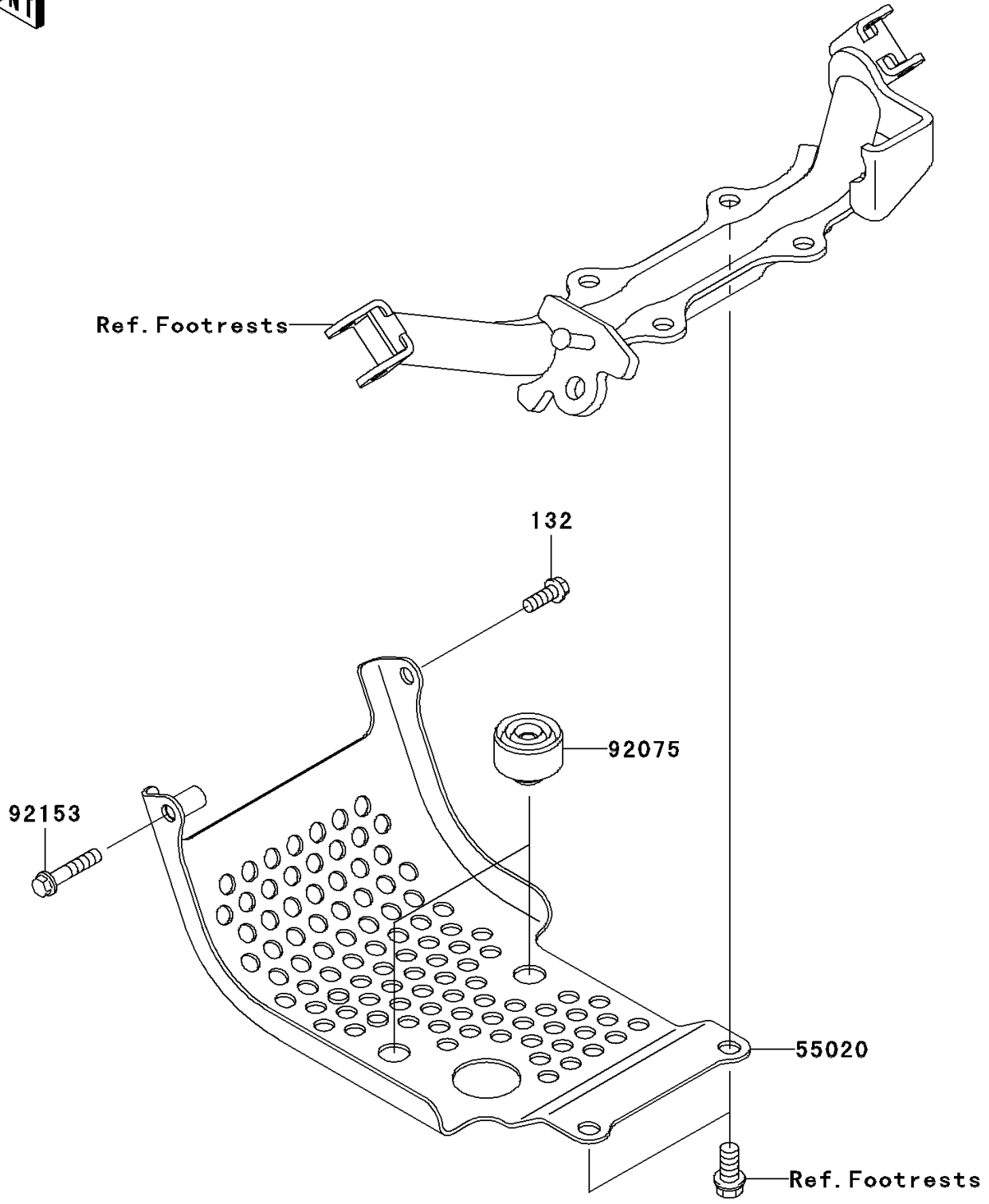

## 2008 KLX®110 PARTS LIST

Guard(s)

ITEM NAME	PART NUMBER	QUANTITY
BOLT-FLANGED-SMALL,6X16 (Ref # 132)	132BD0616	1
GUARD,ENGINE (Ref # 55020)	55020-1784	1
DAMPER (Ref # 92075)	92075-015	2
BOLT,FLANGED,6X30 (Ref # 92153)	92153-1187	1