

# 2007 Vulcan 1500 Classic PARTS DIAGRAM

## Crankcase

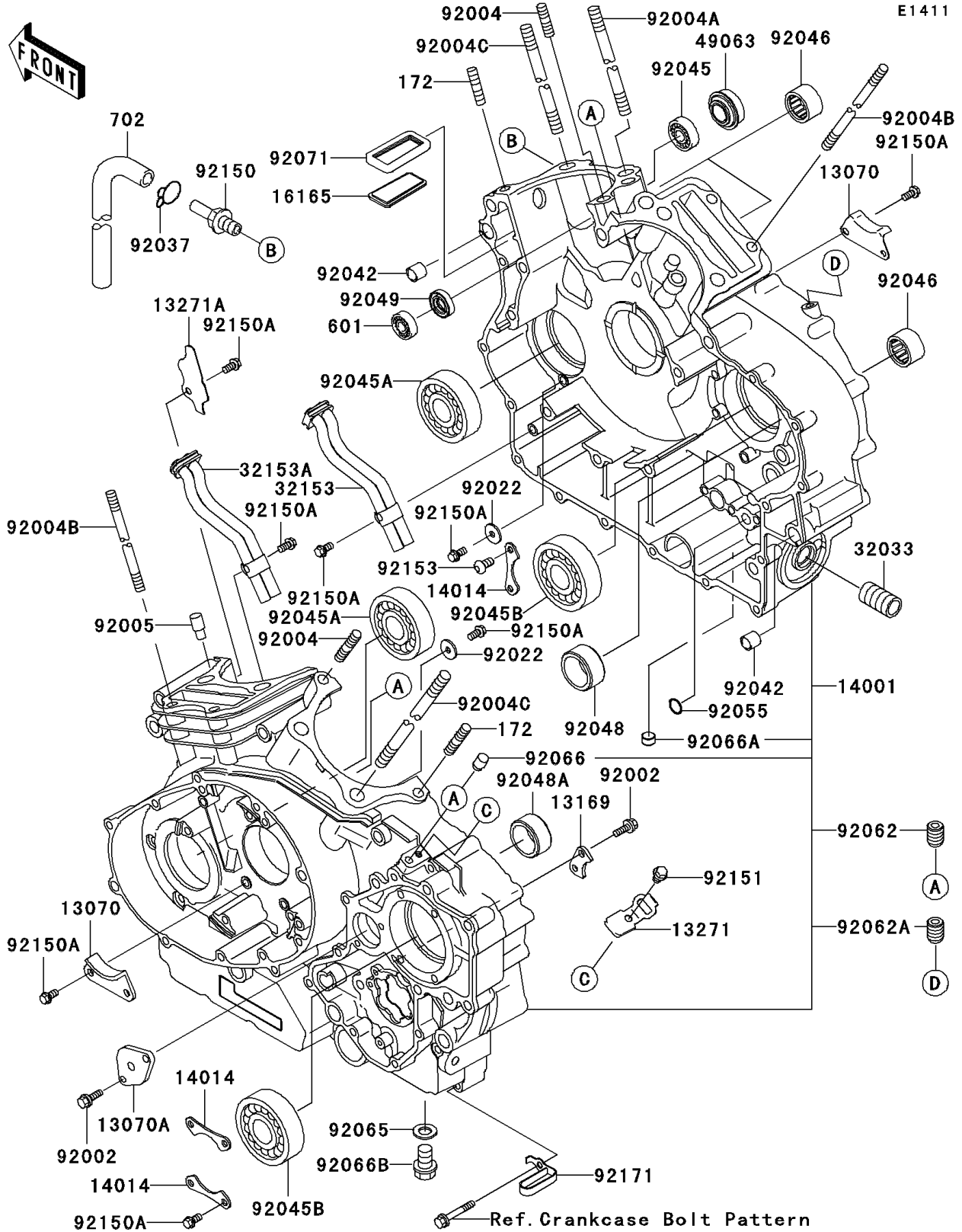

## 2007 Vulcan 1500 Classic PARTS LIST

### Crankcase

ITEM NAME	PART NUMBER	QUANTITY
GUIDE,CAM CHAIN (Ref # 13070)	13070-1168	2
GUIDE (Ref # 13070A)	13070-1372	1
PLATE,GEAR CHANGE DRUM (Ref # 13169)	13169-014	1
PLATE (Ref # 13271)	13271-0210	1
PLATE (Ref # 13271A)	13271-1727	1
SET-CRANKCASE (Ref # 14001)	14001-5394	1
PLATE-POSITION (Ref # 14014)	14014-1084	3
SEPARATOR (Ref # 16165)	16165-1058	1
PIPE,OIL FILTER (Ref # 32033)	32033-1535	1
PIPE,RH CRANKCASE (Ref # 32153)	32153-1262	1
PIPE,LH CRANKCASE (Ref # 32153A)	32153-1263	1
SEAL-MECHANICAL (Ref # 49063)	49063-1057	1
BOLT,6X16 (Ref # 92002)	92002-1439	4
STUD,8X25 (Ref # 92004)	92004-0011	2
STUD,12X250 (Ref # 92004A)	92004-0017	1
STUD,8X231 (Ref # 92004B)	92004-1174	4
STUD,12X250 (Ref # 92004C)	92004-1225	7
FITTING (Ref # 92005)	92005-1155	1
WASHER,6X19.5X2 (Ref # 92022)	92022-1517	2
CLAMP (Ref # 92037)	92037-1835	1
PIN,DOWEL,11X14X12.5 (Ref # 92042)	92042-028	2
BEARING-BALL,6001JRXLLU/5K (Ref # 92045)	92045-1151	1
BEARING-BALL,63/28 (Ref # 92045A)	92045-1189	2
BEARING-BALL,6306SH2 (Ref # 92045B)	92045-1190	2
BEARING-NEEDLE,HK1212V11 (Ref # 92046)	92046-1292	3
RACE (Ref # 92048)	92048-1103	1
RACE (Ref # 92048A)	92048-1113	1
SEAL-OIL,SC 12X22X5 (Ref # 92049)	92049-1228	1
RING-O,13.2X2.4 (Ref # 92055)	92055-1373	1

## 2007 Vulcan 1500 Classic PARTS LIST

### Crankcase

ITEM NAME	PART NUMBER	QUANTITY
NOZZLE,6X8,GREEN (Ref # 92062)	92062-1078	3
NOZZLE (Ref # 92062A)	92062-1089	1
GASKET,12X22X2 (Ref # 92065)	92065-097	1
PLUG,OIL LINE,7.2X8 (Ref # 92066)	92066-1012	1
PLUG (Ref # 92066A)	92066-1110	1
PLUG,OIL DRAIN,12X15 (Ref # 92066B)	92066-1174	1
GROMMET,SEPARATOR (Ref # 92071)	92071-1269	1
BOLT (Ref # 92150)	92150-1161	1
BOLT,6X12 (Ref # 92150A)	92150-1868	13
BOLT,6X8 (Ref # 92151)	92151-1416	1
BOLT,6X12 (Ref # 92153)	92153-0344	2
BOLT-STUD,8X25 (Ref # 172)	172G0825	2
BEARING-BALL (Ref # 601)	601A6001	1
TUBE-RUBBER,4X330 (Ref # 702)	702A04330	1
CLAMP (Ref # 92171)	92171-1273	1