

2007 Vulcan 1500 Classic PARTS DIAGRAM

Crankcase Bolt Pattern

E1412

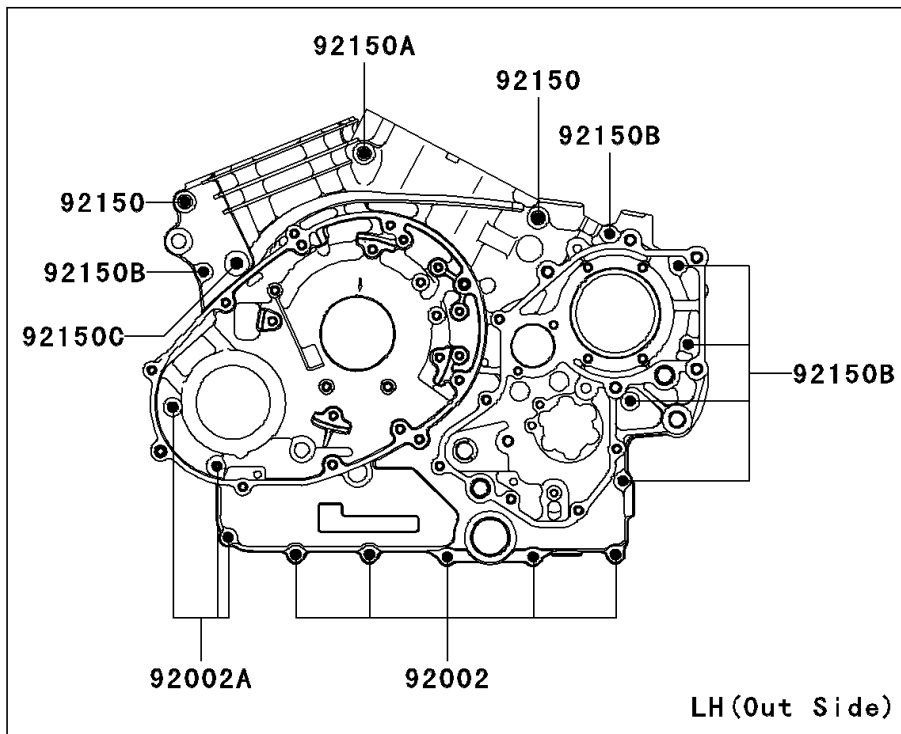
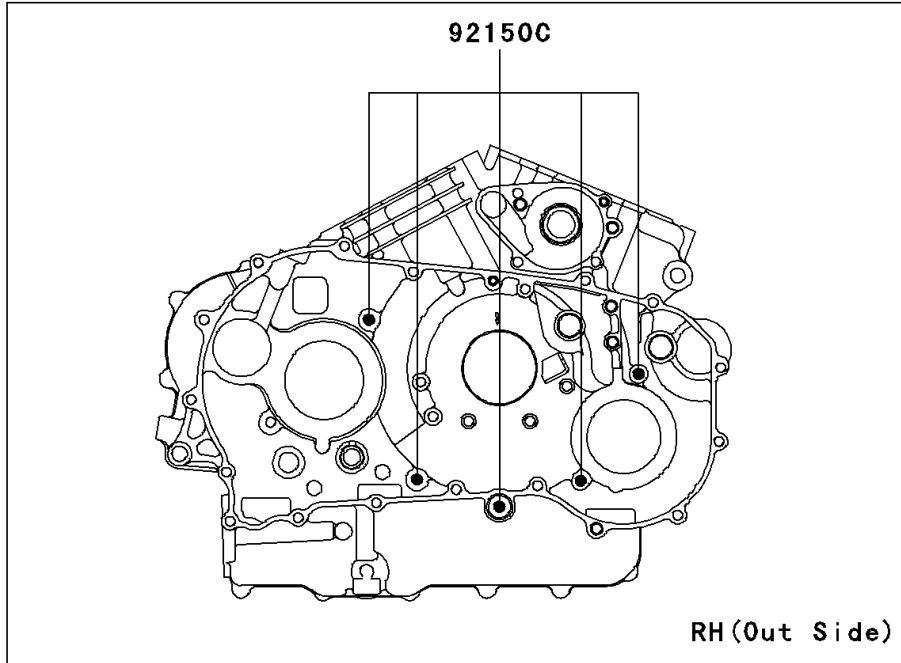

2007 Vulcan 1500 Classic PARTS LIST

Crankcase Bolt Pattern

| ITEM NAME | PART NUMBER | QUANTITY |
|---------------------------------------|-------------|----------|
| BOLT,FLANGED-SMALL,6X40 (Ref # 92002) | 92002-1566 | 5 |
| BOLT,FLANGED,6X80 (Ref # 92002A) | 92002-1568 | 3 |
| BOLT,10X105 (Ref # 92150) | 92150-1993 | 2 |
| BOLT,10X115 (Ref # 92150A) | 92150-1994 | 1 |
| BOLT,6X70 (Ref # 92150B) | 92150-1995 | 6 |
| BOLT,8X90 (Ref # 92150C) | 92150-1996 | 6 |