

2007 Vulcan 1500 Classic PARTS DIAGRAM

Water Pump

E3031

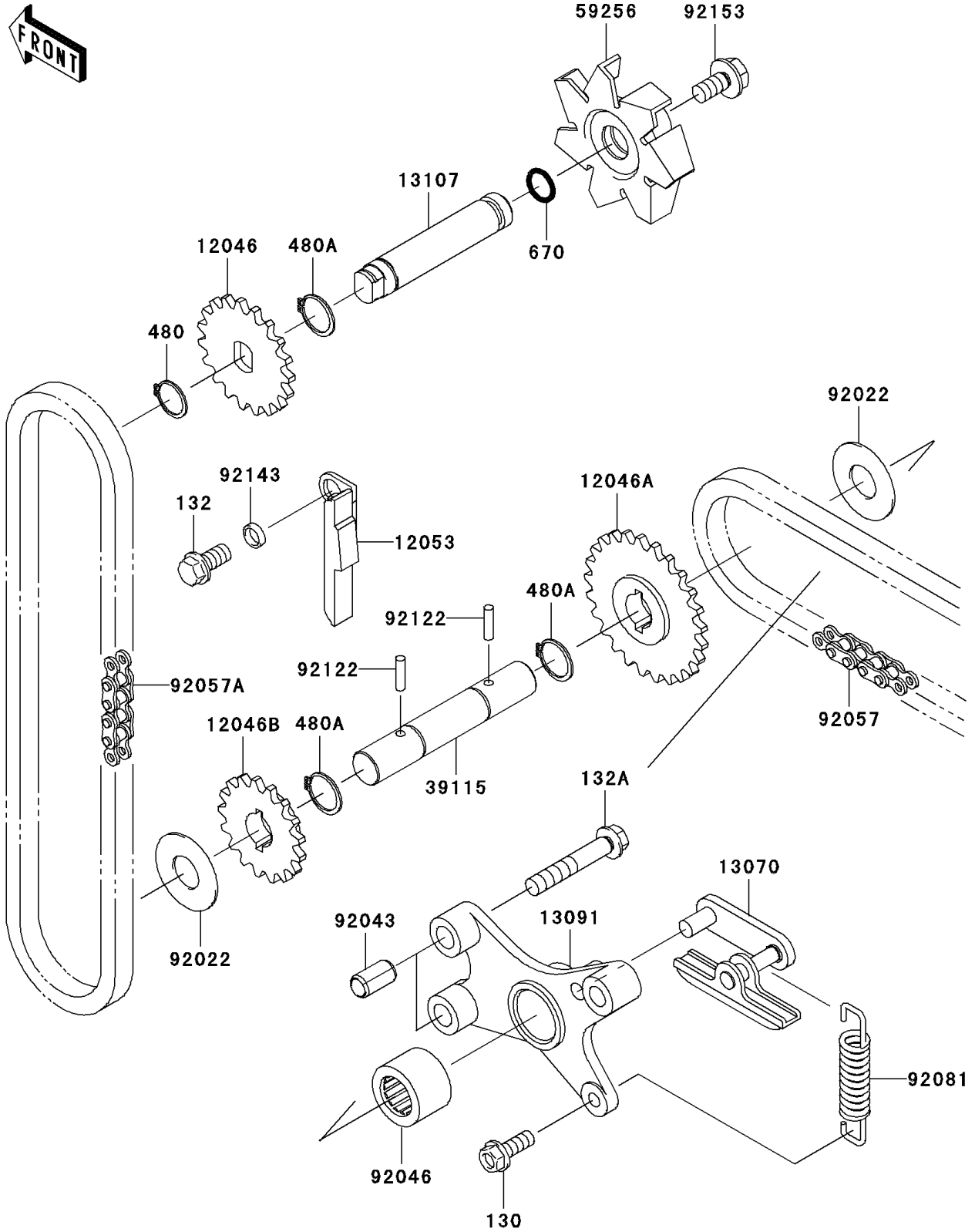

2007 Vulcan 1500 Classic PARTS LIST

Water Pump

| ITEM NAME | PART NUMBER | QUANTITY |
|---|-------------|----------|
| BOLT-FLANGED,5X14 (Ref # 130) | 130D0514 | 1 |
| BOLT-FLANGED-SMALL,6X12 (Ref # 132) | 132G0612 | 1 |
| BOLT-FLANGED-SMALL,6X35 (Ref # 132A) | 132G0635 | 3 |
| CIRCLIP-TYPE-C,11MM (Ref # 480) | 480J1100 | 1 |
| CIRCLIP-TYPE-C,12MM (Ref # 480A) | 480J1200 | 3 |
| O RING,9MM (Ref # 670) | 670D1509 | 1 |
| SPROCKET,OIL PUMP,19T (Ref # 12046) | 12046-1079 | 1 |
| SPROCKET,CRANK IDLER,25T (Ref # 12046A) | 12046-1096 | 1 |
| SPROCKET,IDLER,17T (Ref # 12046B) | 12046-1097 | 1 |
| GUIDE-CHAIN (Ref # 12053) | 12053-1227 | 1 |
| GUIDE (Ref # 13070) | 13070-1178 | 1 |
| HOLDER (Ref # 13091) | 13091-1471 | 1 |
| SHAFT,IMPELLER (Ref # 13107) | 13107-1196 | 1 |
| SHAFT-IDLER (Ref # 39115) | 39115-1058 | 1 |
| IMPELLER (Ref # 59256) | 59256-1066 | 1 |
| WASHER,12X27.5X1.0 (Ref # 92022) | 92022-1852 | 2 |
| PIN,6.2X8X14 (Ref # 92043) | 92043-1263 | 2 |
| BEARING-NEEDLE,HK1212 (Ref # 92046) | 92046-1163 | 1 |
| CHAIN,BS25HX46L (Ref # 92057) | 92057-1230 | 1 |
| CHAIN,BS25HX44L (Ref # 92057A) | 92057-1231 | 1 |
| SPRING,IDLER SHAFT (Ref # 92081) | 92081-1791 | 1 |
| ROLLER,3X15.8 (Ref # 92122) | 92122-1126 | 2 |
| COLLAR (Ref # 92143) | 92143-1123 | 1 |
| BOLT,6X12 (Ref # 92153) | 92153-0009 | 1 |