

2006 Vulcan 1500 Classic PARTS DIAGRAM

Drive Shaft/Final Gear

E3132

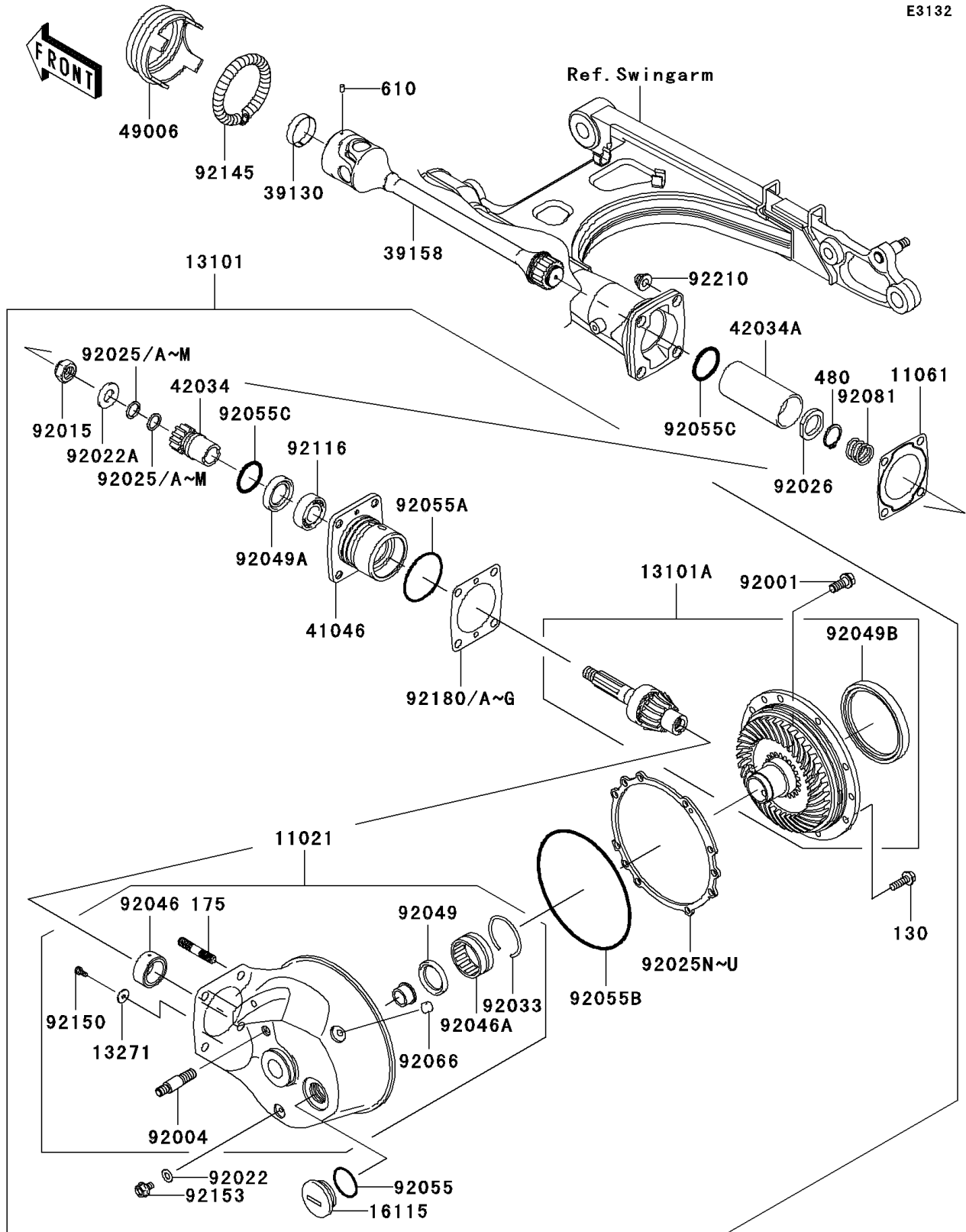

2006 Vulcan 1500 Classic PARTS LIST

Drive Shaft/Final Gear

ITEM NAME	PART NUMBER	QUANTITY
CASE-ASSY,FINAL GEAR (Ref # 11021)	11021-0008	1
GASKET,RR,SWINGARM (Ref # 11061)	11061-1088	1
GEAR-ASSY,FINAL (Ref # 13101)	13101-0038	1
GEAR-ASSY,BEVEL,RR (Ref # 13101A)	13101-5086	1
PLATE (Ref # 13271)	13271-1733	1
CAP-OIL FILLER (Ref # 16115)	16115-1069	1
SPRING-LEAF (Ref # 39130)	39130-1002	1
SHAFT-ASSY-DRIVE (Ref # 39158)	39158-1062	1
HOUSING-BEARING (Ref # 41046)	41046-1103	1
COUPLING (Ref # 42034)	42034-1079	1
COUPLING,DRIVE SHAFT,OUTER (Ref # 42034A)	42034-1178	1
BOOT,DRIVE SHAFT (Ref # 49006)	49006-1226	1
BOLT,10X23 (Ref # 92001)	92001-1778	1
STUD,RR SHOCKABSORBER (Ref # 92004)	92004-1047	1
NUT,16MM (Ref # 92015)	92015-1059	1
WASHER,8.2X16X1 (Ref # 92022)	92022-1086	1
WASHER,16X32X3.2 (Ref # 92022A)	92022-1105	1
SHIM,T=1.30 (Ref # 92025)	92025-1214	AR
SHIM,T=1.32 (Ref # 92025A)	92025-1215	AR
SHIM,T=1.34 (Ref # 92025B)	92025-1216	AR
SHIM,T=1.36 (Ref # 92025C)	92025-1217	AR
SHIM,T=1.38 (Ref # 92025D)	92025-1218	AR
SHIM,T=0.10 (Ref # 92025E)	92025-1219	AR
SHIM,T=0.20 (Ref # 92025F)	92025-1220	AR
SHIM,T=0.30 (Ref # 92025G)	92025-1221	AR
SHIM,T=0.50 (Ref # 92025H)	92025-1222	AR
SHIM,T=0.60 (Ref # 92025I)	92025-1223	AR
SHIM,T=0.70 (Ref # 92025J)	92025-1224	AR
SHIM,T=0.80 (Ref # 92025K)	92025-1225	AR

2006 Vulcan 1500 Classic PARTS LIST

Drive Shaft/Final Gear

ITEM NAME	PART NUMBER	QUANTITY
SHIM,T=0.90 (Ref # 92025L)	92025-1226	AR
SHIM,T=1.00 (Ref # 92025M)	92025-1227	AR
SHIM,T=0.15 (Ref # 92025N)	92025-1783	AR
SHIM,T=0.50 (Ref # 92025O)	92025-1784	AR
SHIM,T=0.60 (Ref # 92025P)	92025-1785	AR
SHIM,T=0.70 (Ref # 92025Q)	92025-1786	AR
SHIM,T=0.80 (Ref # 92025R)	92025-1787	AR
SHIM,T=0.90 (Ref # 92025S)	92025-1788	AR
SHIM,T=1.00 (Ref # 92025T)	92025-1789	AR
SHIM,T=1.20 (Ref # 92025U)	92025-1790	AR
SPACER,26.2X36X2 (Ref # 92026)	92026-1085	1
BOLT-FLANGED,8X25 (Ref # 130)	130Y0825	7
BOLT-STUD-FINE,10X35 (Ref # 175)	175G1035	4
CIRCLIP-TYPE-C,26MM (Ref # 480)	480J2600	1
ROLLER,4X6 (Ref # 610)	610A0406	1
RING-SNAP,52MM (Ref # 92033)	92033-1074	1
BEARING-NEEDLE,RNA4904RD (Ref # 92046)	92046-1168	1
BEARING-NEEDLE,38NQ5020WD (Ref # 92046A)	92046-1169	1
SEAL-OIL,S-35477HS (Ref # 92049)	92049-1025	1
SEAL-OIL,SC32487 (Ref # 92049A)	92049-1033	1
SEAL-OIL,MHSA83X100X9XRT (Ref # 92049B)	92049-1280	1
RING-O,31.7X2.4 (Ref # 92055)	92055-049	1
RING-O,57.6X2.4 (Ref # 92055A)	92055-1038	1
RING-O,154X3 (Ref # 92055B)	92055-1165	1
RING-O,32.7X3.5 (Ref # 92055C)	92055-1646	2
PLUG (Ref # 92066)	92066-1110	1
SPRING (Ref # 92081)	92081-1183	1
BEARING-ROLLER,4T32005X (Ref # 92116)	92116-1004	1
SPRING,BOOT (Ref # 92145)	92145-1162	1

2006 Vulcan 1500 Classic PARTS LIST

Drive Shaft/Final Gear

ITEM NAME	PART NUMBER	QUANTITY
BOLT,5X10 (Ref # 92150)	92150-1806	1
BOLT,FLANGED,8X12 (Ref # 92153)	92153-1277	1
SHIM,T=0.15 (Ref # 92180)	92180-0009	AR
SHIM,T=0.50 (Ref # 92180A)	92180-0010	AR
SHIM,T=0.60 (Ref # 92180B)	92180-0011	AR
SHIM,T=0.70 (Ref # 92180C)	92180-0012	AR
SHIM,T=0.80 (Ref # 92180D)	92180-0013	AR
SHIM,T=0.90 (Ref # 92180E)	92180-0014	AR
SHIM,T=1.00 (Ref # 92180F)	92180-0015	AR
SHIM,T=1.20 (Ref # 92180G)	92180-0016	AR
NUT,CAP,10MM (Ref # 92210)	92210-1121	4