

2007 Vulcan 1500 Classic PARTS DIAGRAM

Brake Pedal/Torque Link

F2260

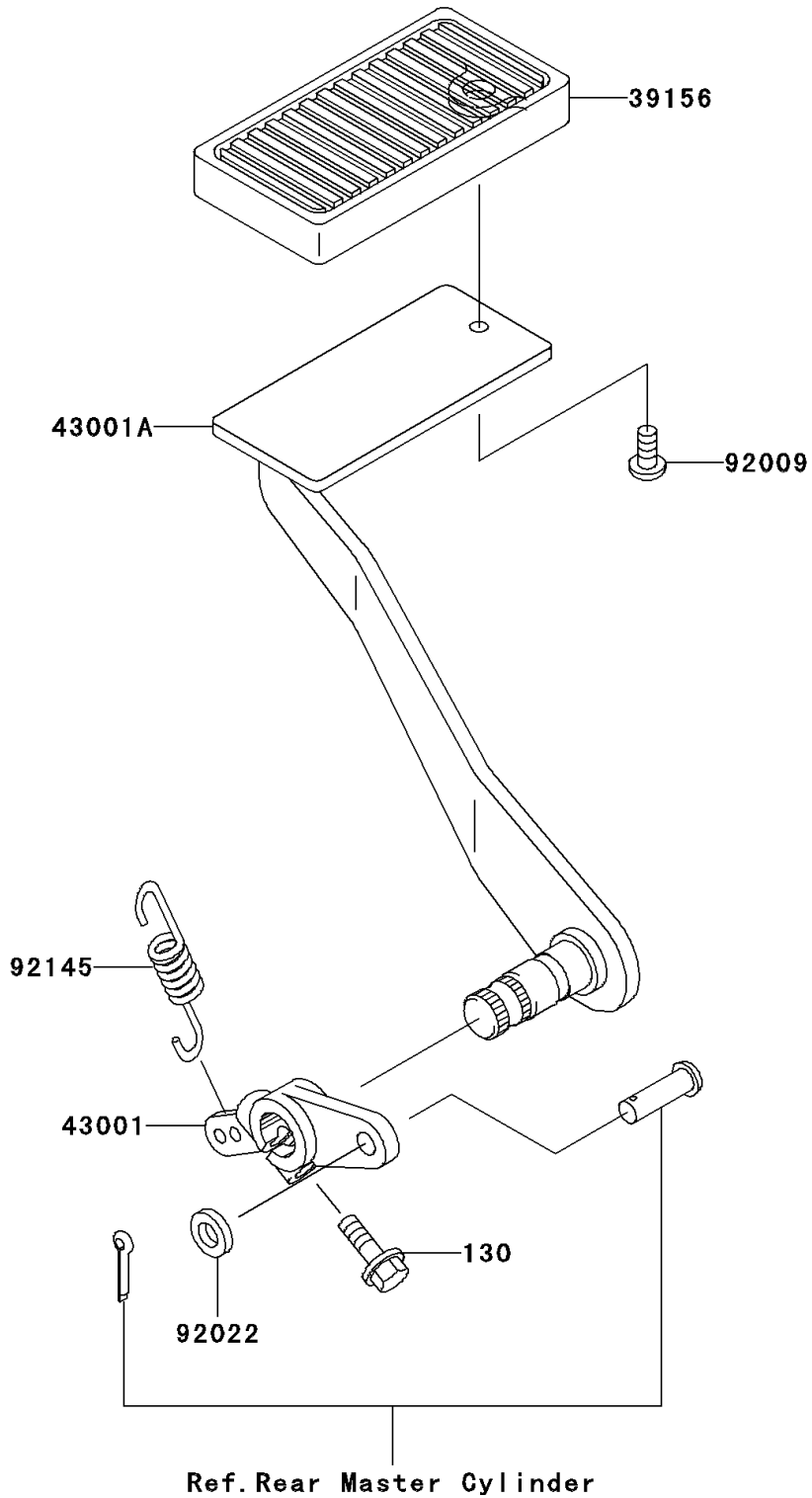

2007 Vulcan 1500 Classic PARTS LIST

Brake Pedal/Torque Link

ITEM NAME	PART NUMBER	QUANTITY
BOLT-FLANGED,8X30 (Ref # 130)	130J0830	1
PAD,BRAKE PEDAL (Ref # 39156)	39156-1624	1
LEVER-BRAKE (Ref # 43001)	43001-1431	1
LEVER-BRAKE,PEDAL (Ref # 43001A)	43001-1433	1
SCREW,6X8 (Ref # 92009)	92009-1677	1
WASHER,8.5X16X1.2 (Ref # 92022)	92022-1582	1
SPRING,BRAKE PEDAL RETURN (Ref # 92145)	92145-0191	1