

# 2007 Vulcan 1500 Classic PARTS DIAGRAM

Chassis Electrical Equipment

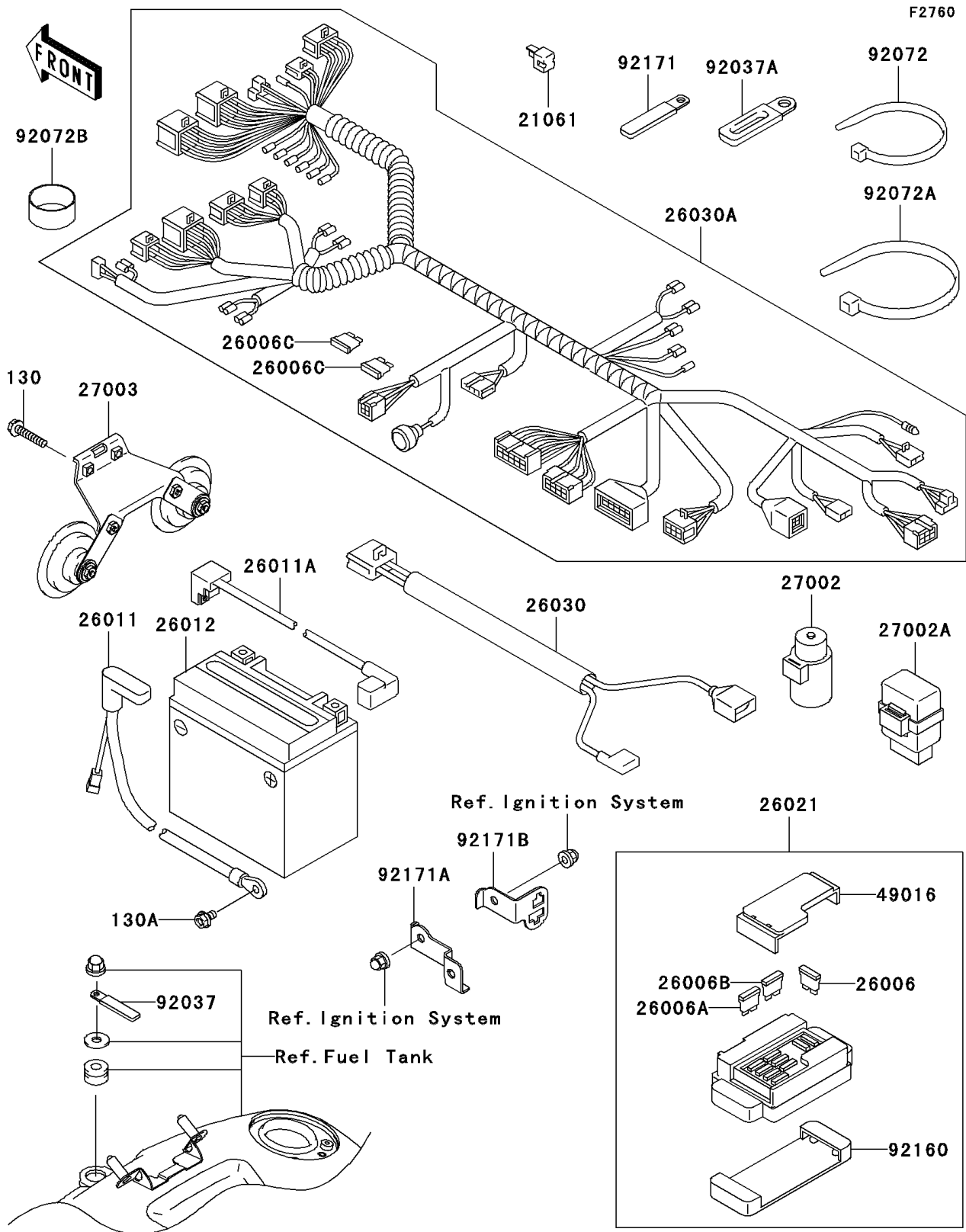

## 2007 Vulcan 1500 Classic PARTS LIST

### Chassis Electrical Equipment

ITEM NAME	PART NUMBER	QUANTITY
BOLT-FLANGED,6X30 (Ref # 130)	130J0630	2
BOLT-FLANGED,6X10 (Ref # 130A)	130V0610	1
RECTIFIER (Ref # 21061)	21061-1003	2
FUSE,30A-G (Ref # 26006)	26006-1006	1
FUSE,10A-R (Ref # 26006A)	26006-1007	7
FUSE,15A-B (Ref # 26006B)	26006-1061	1
FUSE,15A-B (Ref # 26006C)	26006-1069	2
WIRE-LEAD,BATTERY(-) (Ref # 26011)	26011-1750	1
WIRE-LEAD,BATTERY(+) (Ref # 26011A)	26011-1764	1
BATTERY,MF,FTZ16-BS,12V 18AH (Ref # 26012)	26012-1371	1
JUNCTION BOX (Ref # 26021)	26021-0002	1
HARNESS,SUB (Ref # 26030)	26030-1450	1
HARNESS,MAIN (Ref # 26030A)	26030-1852	1
RELAY-ASSY (Ref # 27002)	27002-1051	1
RELAY-ASSY,SIGNAL LAMP (Ref # 27002A)	27002-1113	1
HORN (Ref # 27003)	27003-1406	1
COVER-SEAL,FUSE (Ref # 49016)	49016-0005	1
CLAMP (Ref # 92037)	92037-113	1
CLAMP (Ref # 92037A)	92037-1780	2
BAND,L=202 (Ref # 92072)	92072-1195	9
BAND,L=365 (Ref # 92072A)	92072-1197	2
BAND (Ref # 92072B)	92072-1393	1
DAMPER,JUNCTION BOX (Ref # 92160)	92160-1650	1
CLAMP (Ref # 92171)	92171-0652	2
CLAMP (Ref # 92171A)	92171-1262	1
CLAMP,HARNESS (Ref # 92171B)	92171-1263	1