

2007 Vulcan 1500 Classic PARTS DIAGRAM

Ignition Switch/Locks/Reflectors

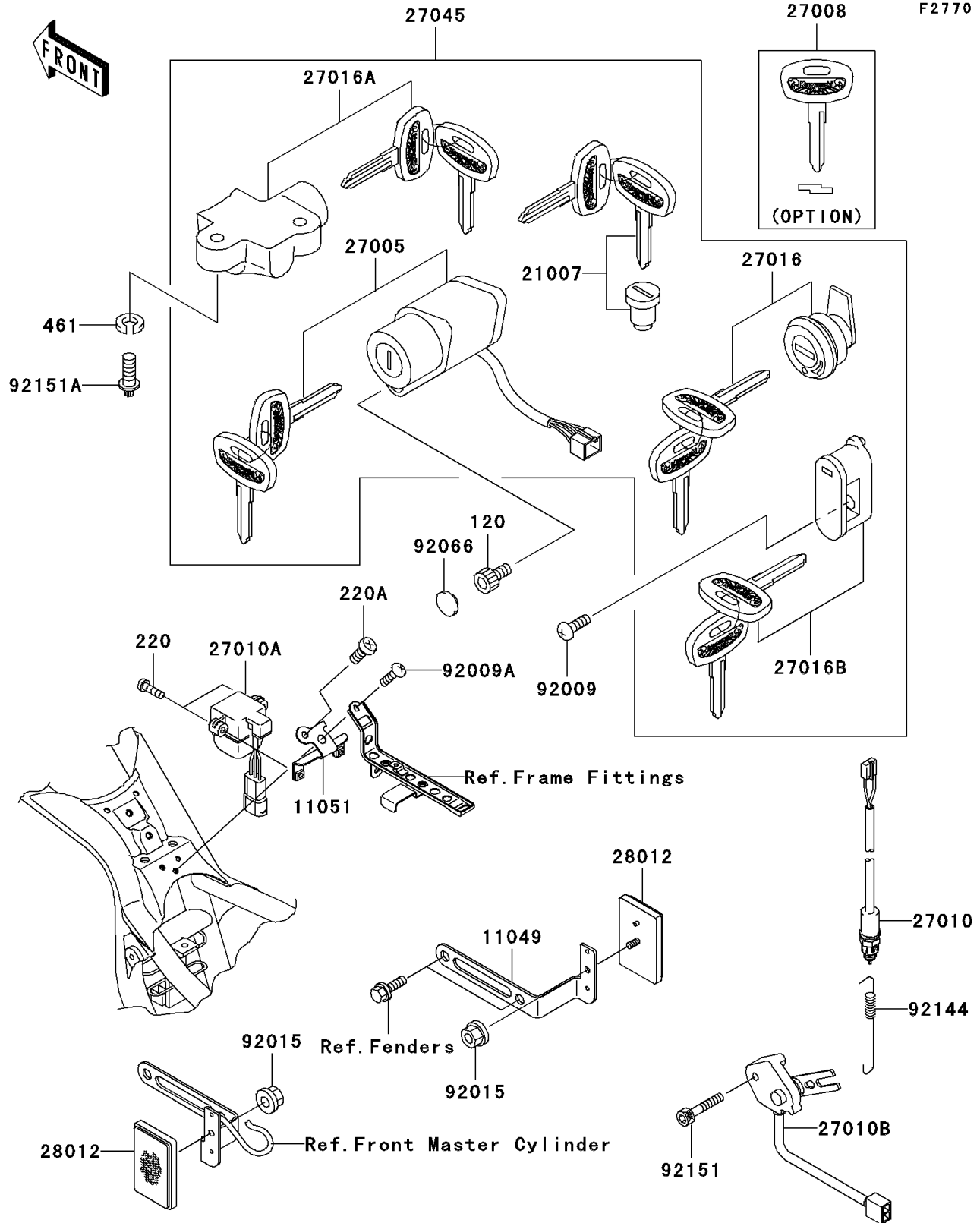

2007 Vulcan 1500 Classic PARTS LIST

Ignition Switch/Locks/Reflectors

ITEM NAME	PART NUMBER	QUANTITY
BOLT-SOCKET,5X12 (Ref # 120)	120P0512	1
SCREW-PAN-CROS,4X20 (Ref # 220)	220C0420	2
SCREW-PAN-CROS,6X12 (Ref # 220A)	220C0612	1
WASHER-SPRING (Ref # 461)	461L0600	2
BRACKET (Ref # 11049)	11049-1820	1
BRACKET,DOWN SENSOR (Ref # 11051)	11051-1763	1
ROTOR,LOCK,TANK CAP (Ref # 21007)	21007-5047	1
SWITCH-ASSY-IGNITION (Ref # 27005)	27005-1256	1
KEY-LOCK,BLANK (Ref # 27008)	27008-1208	1
SWITCH,REAR BRAKE (Ref # 27010)	27010-1412	1
SWITCH,DOWN SENSOR (Ref # 27010A)	27010-1416	1
SWITCH,SIDE STAND (Ref # 27010B)	27010-1464	1
LOCK-ASSY,LID (Ref # 27016)	27016-5267	1
LOCK-ASSY,STEERING (Ref # 27016A)	27016-5269	1
LOCK-ASSY,HELMET (Ref # 27016B)	27016-5316	2
SWITCH-ASSY (Ref # 27045)	27045-5245	1
REFLECTOR-REFLEX,FR (Ref # 28012)	28012-1009	2
SCREW,5X12 (Ref # 92009)	92009-1296	2
SCREW,6X16 (Ref # 92009A)	92009-1621	1
NUT,FLANGED,5MM (Ref # 92015)	92015-1656	2
PLUG (Ref # 92066)	92066-1435	1
SPRING,REAR BRAKE SWITCH (Ref # 92144)	92144-1141	1
BOLT,SOCKET,6X35 (Ref # 92151)	92151-1390	1
BOLT,TORX,6X22 (Ref # 92151A)	92151-1946	2