

2009 Brute Force® 650 4x4 PARTS DIAGRAM

Chassis Electrical Equipment

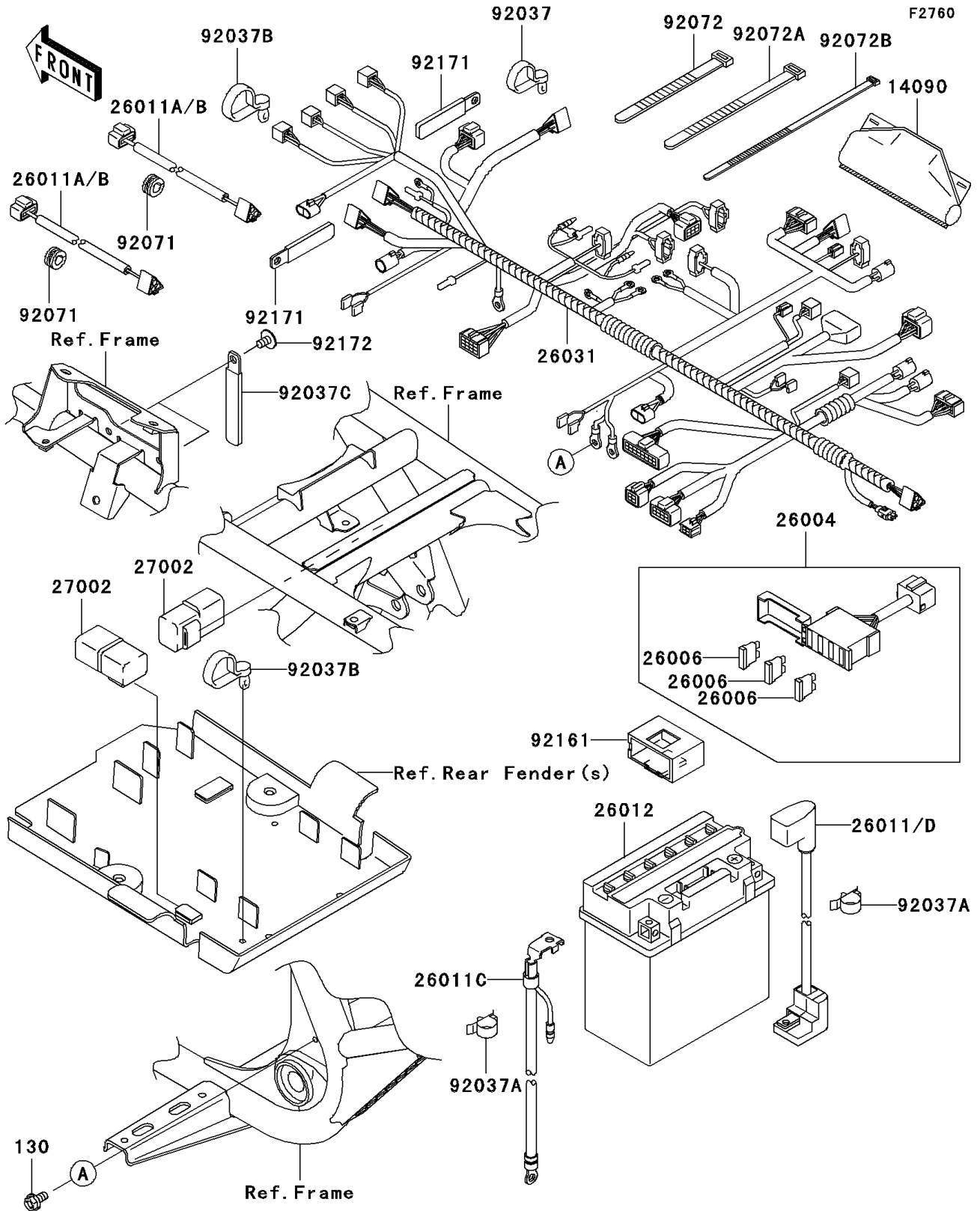

2009 Brute Force® 650 4x4 PARTS LIST

Chassis Electrical Equipment

ITEM NAME	PART NUMBER	QUANTITY
BOLT-FLANGED,6X12 (Ref # 130)	130AA0612	1
COVER,COUPLER (Ref # 14090)	14090-1331	2
FUSE-ASSY (Ref # 26004)	26004-0010	1
FUSE,10A-R (Ref # 26006)	26006-1007	3
WIRE-LEAD,BATTERY(+) (Ref # 26011)	26011-0142	1
WIRE-LEAD,HEAD LAMP (Ref # 26011A)	26011-0143	2
WIRE-LEAD,BATTERY(-) (Ref # 26011C)	26011-1752	1
BATTERY,MF,KMX14-BS,12V 12AH (Ref # 26012)	26012-1414	1
HARNESS,MAIN (Ref # 26031)	26031-0760	1
RELAY-ASSY (Ref # 27002)	27002-1086	2
CLAMP,SPEED,L=58 (Ref # 92037)	92037-1163	1
CLAMP,HARNESS (Ref # 92037A)	92037-1878	2
CLAMP,SPEED,L=80.5 (Ref # 92037B)	92037-1903	5
CLAMP (Ref # 92037C)	92037-1993	2
GROMMET (Ref # 92071)	92071-1128	2
BAND,L=123 (Ref # 92072)	92072-030	2
BAND,L=149 (Ref # 92072A)	92072-031	2
BAND,L=188 (Ref # 92072B)	92072-1239	25
DAMPER,FUSE (Ref # 92161)	92161-1136	1
CLAMP (Ref # 92171)	92171-0652	2
SCREW,6X10 (Ref # 92172)	92172-0005	2