

2007 Prairie 360 4X4 PARTS DIAGRAM

Driven Converter/Drive Belt

E1392

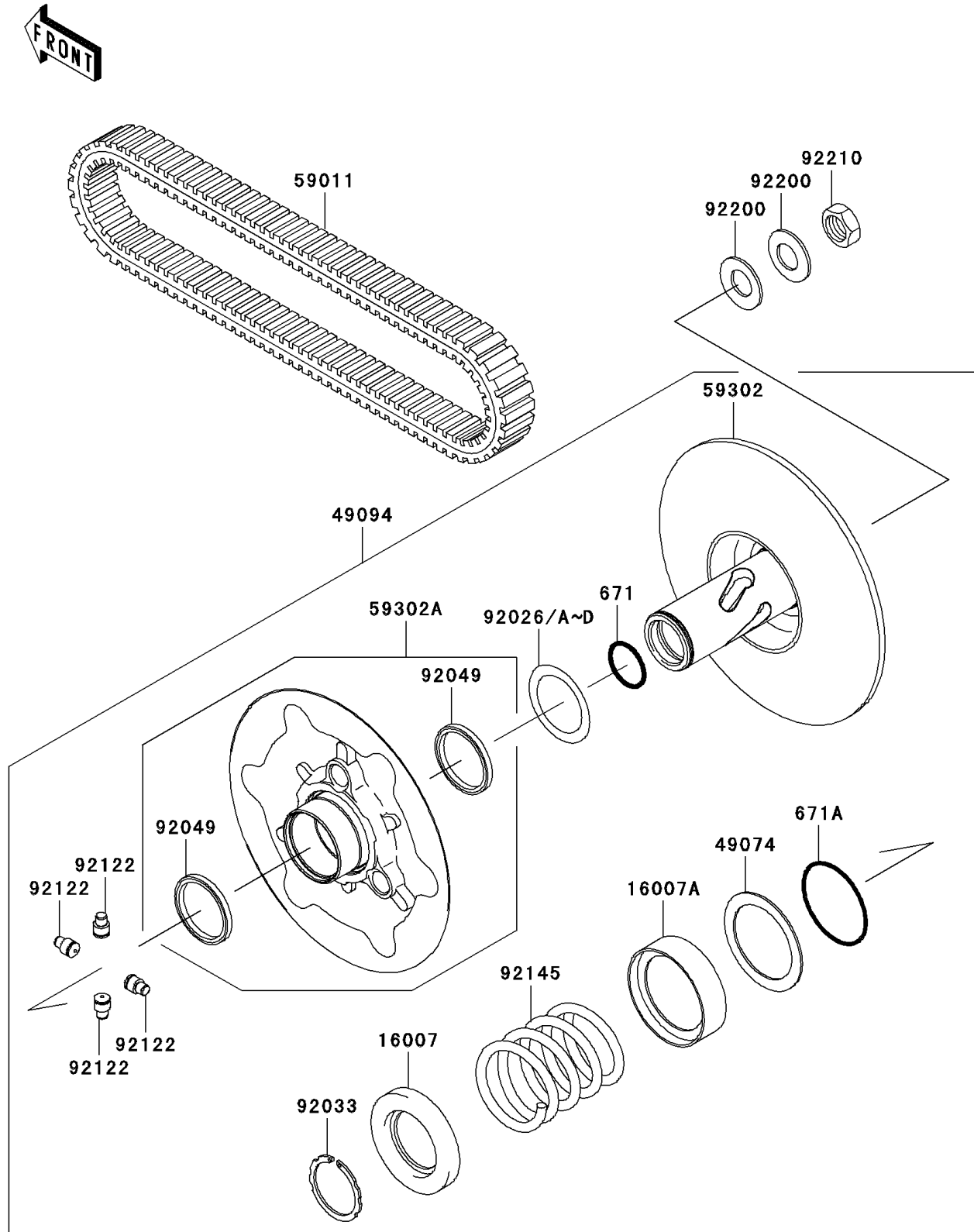

2007 Prairie 360 4X4 PARTS LIST

Driven Converter/Drive Belt

ITEM NAME	PART NUMBER	QUANTITY
O RING (Ref # 671)	671D2530	1
O RING (Ref # 671A)	671D2550	1
SEAT-SPRING (Ref # 16007)	16007-1203	1
SEAT-SPRING,SHEAVE MOVABLE (Ref # 16007A)	16007-1221	1
PLATE-THRUST (Ref # 49074)	49074-1055	1
CONVERTER-ASSY-DRIVEN (Ref # 49094)	49094-0019	1
BELT (Ref # 59011)	59011-0003	1
SHEAVE-COMP (Ref # 59302)	59302-0001	1
SHEAVE-COMP (Ref # 59302A)	59302-0002	1
SPACER,T=0.30 (Ref # 92026)	92026-0034	AR
SPACER,T=1.00 (Ref # 92026A)	92026-1565	AR
SPACER,T=0.60 (Ref # 92026B)	92026-1569	AR
SPACER,T=1.40 (Ref # 92026C)	92026-1570	AR
SPACER,T=0.80 (Ref # 92026D)	92026-1617	AR
RING-SNAP (Ref # 92033)	92033-1317	1
SEAL-OIL (Ref # 92049)	92049-1528	2
ROLLER (Ref # 92122)	92122-1209	4
SPRING,PURPLE (Ref # 92145)	92145-1499	1
WASHER (Ref # 92200)	92200-1505	2
NUT,18MM (Ref # 92210)	92210-1367	1