

2007 Prairie 360 PARTS DIAGRAM

Generator

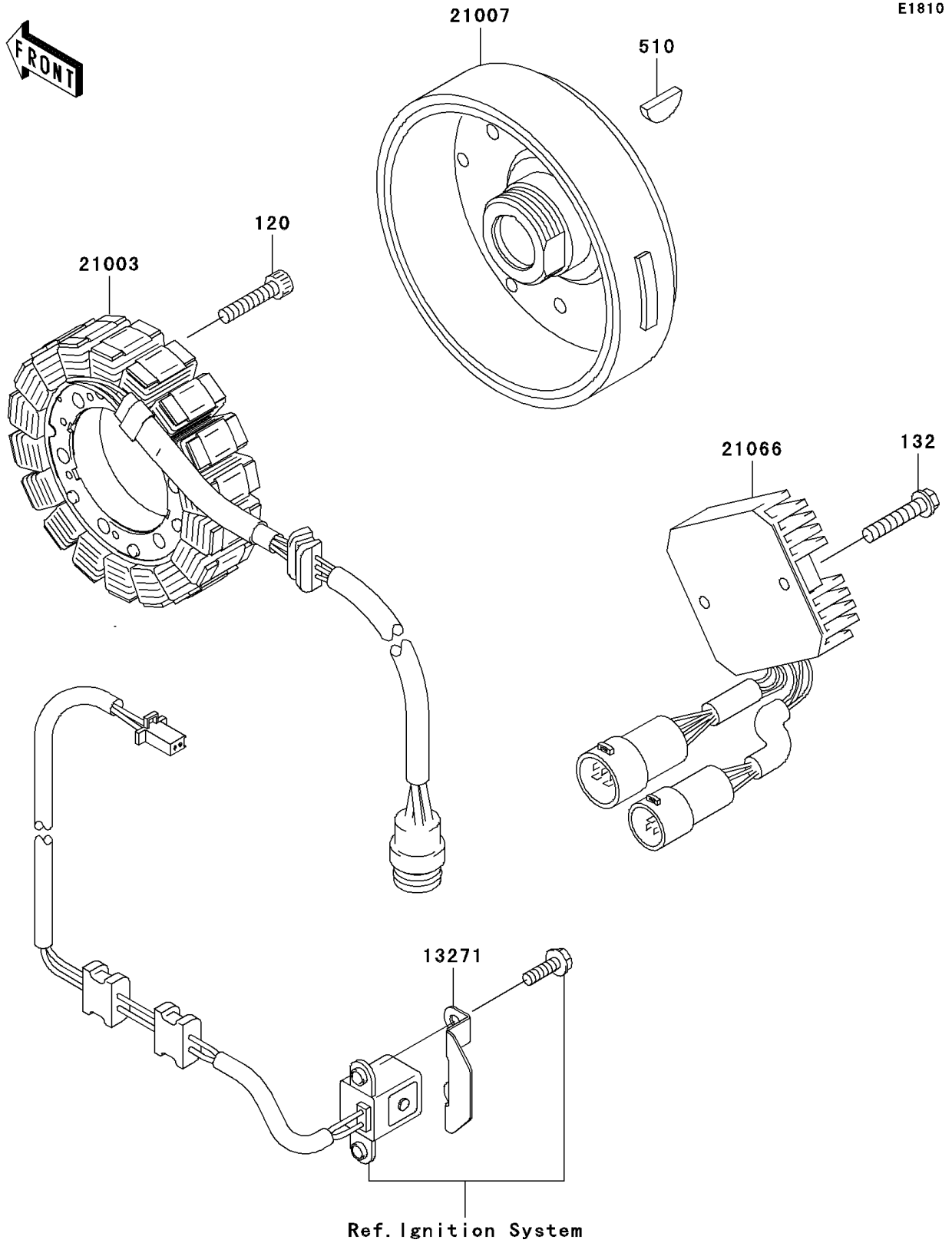

2007 Prairie 360 PARTS LIST

Generator

ITEM NAME	PART NUMBER	QUANTITY
BOLT-SOCKET,6X28 (Ref # 120)	120CA0628	3
BOLT-FLANGED-SMALL,6X30 (Ref # 132)	132BD0630	2
KEY-WOODRUFF (Ref # 510)	510A4200	1
PLATE (Ref # 13271)	13271-1369	1
STATOR (Ref # 21003)	21003-1387	1
ROTOR (Ref # 21007)	21007-1400	1
REGULATOR-VOLTAGE (Ref # 21066)	21066-1112	1