

1980 KZ550-A1 PARTS DIAGRAM

CYLINDER HEAD

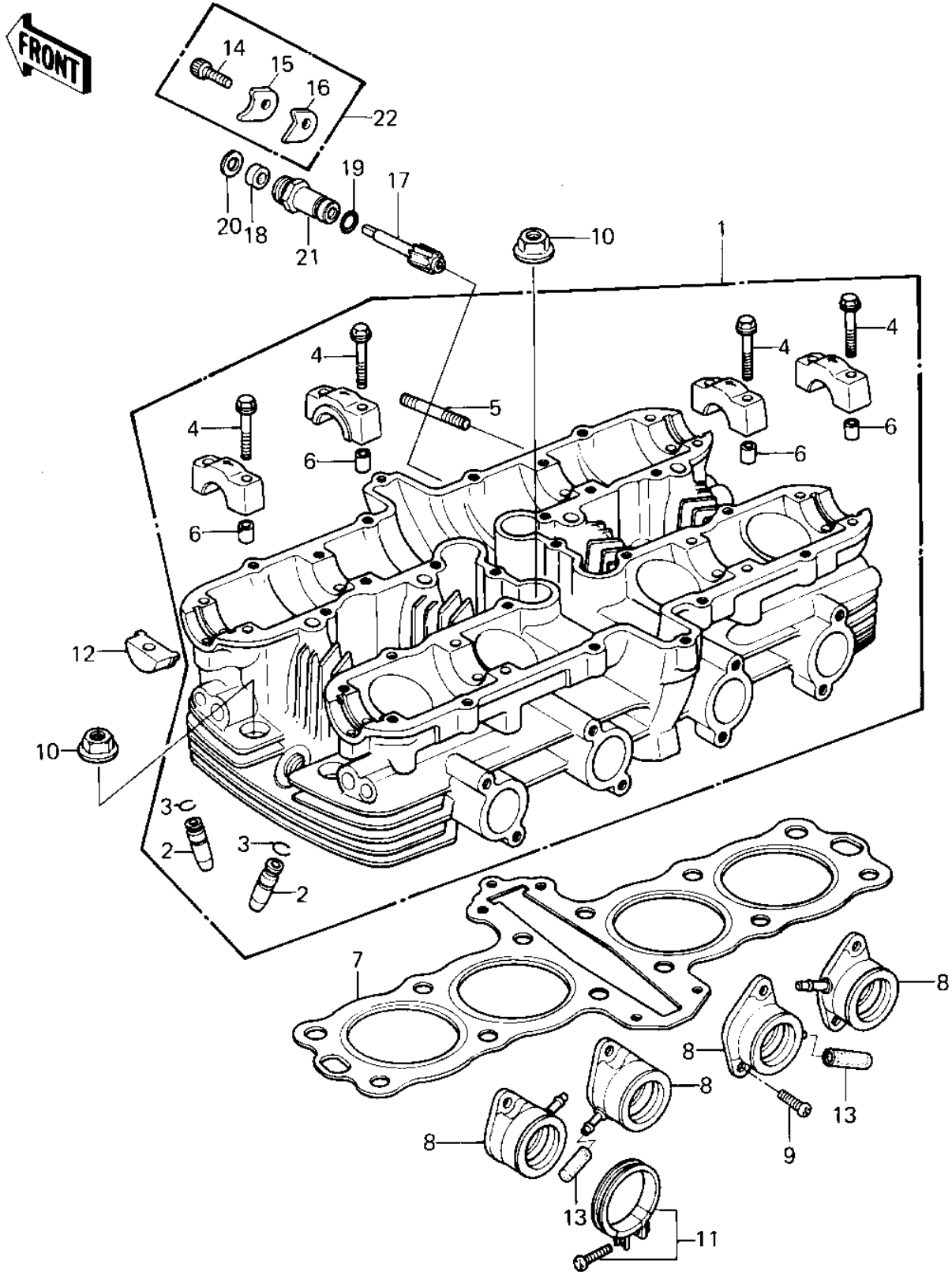

1980 KZ550-A1 PARTS LIST

CYLINDER HEAD

ITEM NAME	PART NUMBER	QUANTITY
HEAD-ASSY-CYL,SILVER (Ref # 1)	11002-1063	1
HEAD-ASSY-CYL,F.BLACK (Ref # 1)	11002-1062	1
GUIDE,VALVE (Ref # 2)	49002-1005	8
CIRCLIP-VALVE (Ref # 3)	92036-023	8
BOLT,FLANGED,6X38 (Ref # 4)	92001-1105	16
STUD,6X27 (Ref # 5)	92004-066	8
PIN-DOWEL (Ref # 6)	92042-007	16
GASKET-HEAD (Ref # 7)	11004-1212	1
HOLDER,CARBURETOR (Ref # 8)	16065-1014	4
SCREW PAN HEAD 6X14 (Ref # 9)	220B0614	8
NUT-8MM (Ref # 10)	92015-1143	12
CLAMP,CARBURETOR,40MM (Ref # 11)	92037-1129	4
PLUG,CAMSHAFT,11.35X1 (Ref # 12)	92066-1111	4
RUBBER PLUG (Ref # 13)	92068-006	2
RUBBER PLUG (Ref # 13)	92068-006	4
BOLT,6X14 (Ref # 14)	120P0614	1
HOLDER,TACHOMETER2.3T (Ref # 15)	13091-1008	1
HOLDER,TACHOMETR,3.2T (Ref # 16)	13091-1009	1
GEAR,TACHOMETER,10T (Ref # 17)	13223-011	1
OIL SEAL (Ref # 18)	92050-075	1
RING-O,10MM (Ref # 19)	92055-1149	1
GASKET,TACHOMETER GER (Ref # 20)	92065-103	1
GUIDE,TACHOMETER GEAR (Ref # 21)	92087-010	1
HOLDER SET,TACHOMETER (Ref # 22)	13091-5001	1